



USER MANUAL

RUT230 3G Router



1 Legal notice

Copyright © 2017 TELTONIKA Ltd. All rights reserved. Reproduction, transfer, distribution or storage of part or all of the contents in this document in any form without the prior written permission of TELTONIKA Ltd is prohibited. The manufacturer reserves the right to modify the product and manual for the purpose of technical improvement without prior notice.

Other product and company names mentioned herein may be trademarks or trade names of their respective owners.

2 Attention



Before using the device we strongly recommend reading this user manual first.



Do not rip open the device. Do not touch the device if the device block is broken.



All wireless devices for data transferring may be susceptible to interference, which could affect performance.



The device is not water-resistant. Keep it dry.

Device is powered by low voltage +9V DC power adapter.

Table of Contents

Legal notice.....	3
Attention.....	3
SAFETY INFORMATION.....	8
Device connection	9
1 Introduction	10
2 Specifications.....	10
2.1 Ethernet.....	10
2.2 WiFi.....	10
2.3 Hardware	10
2.4 Electrical, Mechanical & Environmental.....	10
2.5 Applications	11
3 Setting up your router	12
3.1 Installation	12
3.1.1 Front Panel and Back Panel	12
3.1.2 Connection status LED	12
3.1.3 Hardware installation	13
3.2 Logging in.....	13
4 Operation Modes.....	17
5 Powering Options	17
5.1 Powering the device from higher voltage.....	17
6 Status.....	18
6.1 Overview.....	18
6.2 System Information	19
6.3 Network Information.....	20
6.4 Device information	30
6.5 Services.....	31
6.6 Routes.....	32
6.6.1 ARP	32
6.6.2 Active IP-Routes.....	32
6.6.3 Active IPv6-Routes.....	32
6.7 Graphs.....	34
6.7.1 Mobile Signal Strength	34
6.7.2 Realtime Load	35
6.7.3 Realtime Traffic.....	36

6.7.4 Realtime Wireless	37
6.7.5 Realtime Connections	38
6.8 Mobile Traffic	39
6.9 Speed Test	40
6.10 Events Log	40
6.10.1 All Events	40
6.10.2 System Events	41
6.10.3 Network Events	42
6.10.4 Events Reporting	43
6.10.5 Reporting Configuration	44
7 Network	47
7.1 Mobile	47
7.1.1 General	47
7.1.2 Mobile Data Limit	49
7.2 WAN	51
7.2.1 Operation Mode	51
7.2.2 Common configuration	51
7.3 LAN	58
7.3.1 Configuration	58
7.3.2 DHCP Server	59
7.4 Wireless	62
7.5 VLAN	65
7.5.1 VLAN Networks	65
7.5.2 LAN Networks	65
7.6 Firewall	66
7.6.1 General Settings	66
7.6.2 DMZ	67
7.6.3 Port Forwarding	67
7.6.4 Traffic Rules	69
7.6.5 Custom Rules	74
7.6.6 DDOS Prevention	74
7.6.7 Port Scan Prevention	77
7.7 Routing	77
7.7.1 Static Routes	77
7.7.2 Dynamic Routes	79

8 Services	82
8.1 VRRP	82
8.1.1 VRRP LAN Configuration Settings	82
8.1.2 Check Internet connection	82
8.2 Web Filter	83
8.2.1 Site blocking.....	83
8.2.2 Proxy Based Content Blocker	83
8.3 NTP	84
8.4 VPN	85
8.4.1 OpenVPN	85
8.4.2 IPSec	89
8.4.3 GRE Tunnel.....	92
8.4.4 PPTP	94
8.4.5 L2TP	96
8.5 Dynamic DNS	97
8.6 SMS Utilities.....	99
8.6.1 SMS Utilities.....	99
8.6.2 Call Utilities.....	107
8.6.3 User Groups	108
8.6.4 SMS Management	109
8.6.5 Remote Configuration	111
8.6.6 Statistics.....	114
8.7 SNMP	115
8.7.1 SNMP Settings	115
8.7.2 TRAP Settings.....	116
8.8 SMS Gateway	117
8.8.1 Post/Get Configuration	117
8.8.2 Scheduled Messages.....	119
8.8.3 Auto Reply Configuration	119
8.8.4 SMPP.....	120
8.9 Hotspot	121
8.9.1 General settings.....	121
8.9.2 Internet Access Restriction Settings	123
8.9.3 Logging.....	123
8.9.4 Landing Page.....	125

8.9.5 Radius server configuration	126
8.9.6 Statistics	127
8.10 CLI	128
8.11 Auto Reboot.....	129
8.11.1 Ping Reboot	129
8.11.2 Periodic Reboot	130
8.12 Input/Output	131
8.12.1 Main information.....	131
8.12.2 Status	131
8.12.3 Input	133
8.12.4 Output	134
8.13 QoS	138
9 System.....	139
9.1 Setup Wizard.....	139
9.2 Profiles	141
9.3 Administration	141
9.3.1 General	141
9.3.2 Troubleshoot.....	143
9.3.3 Backup	144
9.3.4 Diagnostics.....	146
9.3.5 MAC Clone	147
9.3.6 Overview.....	147
9.3.7 Monitoring.....	148
9.4 User scripts	149
9.5 Firmware.....	149
9.5.1 Firmware.....	149
9.5.2 FOTA.....	150
9.6 Reboot	151
10 Device Recovery.....	152
10.1 Reset button	152
10.2 Bootloader's WebUI.....	152
11 Glossary	153

3 SAFETY INFORMATION

In this document you will be introduced on how to use a RUT230 router safely. We suggest you to adhere to the following recommendations in order to avoid personal injuries and or property damage.

You have to be familiar with the safety requirements before using the device!

To avoid burning and voltage caused traumas, of the personnel working with the device, please follow these safety requirements.



The device is intended for supply from a Limited Power Source (LPS) that power consumption should not exceed 15VA and current rating of over current protective device should not exceed 2A.



The highest transient over voltage in the output (secondary circuit) of used PSU shall not exceed 36V peak.



The device can be used with the Personal Computer (first safety class) or Notebook (second safety class). Associated equipment: PSU (power supply unit) (LPS) and personal computer (PC) shall comply with the requirements of standard EN 60950-1.



Do not mount or service the device during a thunderstorm.



To avoid mechanical damages to the device it is recommended to transport it packed in a damage-proof pack.



Protection in primary circuits of associated PC and PSU (LPS) against short circuits and earth faults of associated PC shall be provided as part of the building installation.

To avoid mechanical damages to the device it is recommended to transport it packed in a damage-proof pack. While using the device, it should be placed so, that its indicating LEDs would be visible as they inform in which working mode the device is and if it has any working problems.

Protection against over current, short circuiting and earth faults should be provided as a part of the building installation.

Signal level of the device depends on the environment in which it is working. In case the device starts working insufficiently, please refer to qualified personnel in order to repair this product. We recommend forwarding it to a repair center or the manufacturer. There are no exchangeable parts inside the device.

3.1 Device connection

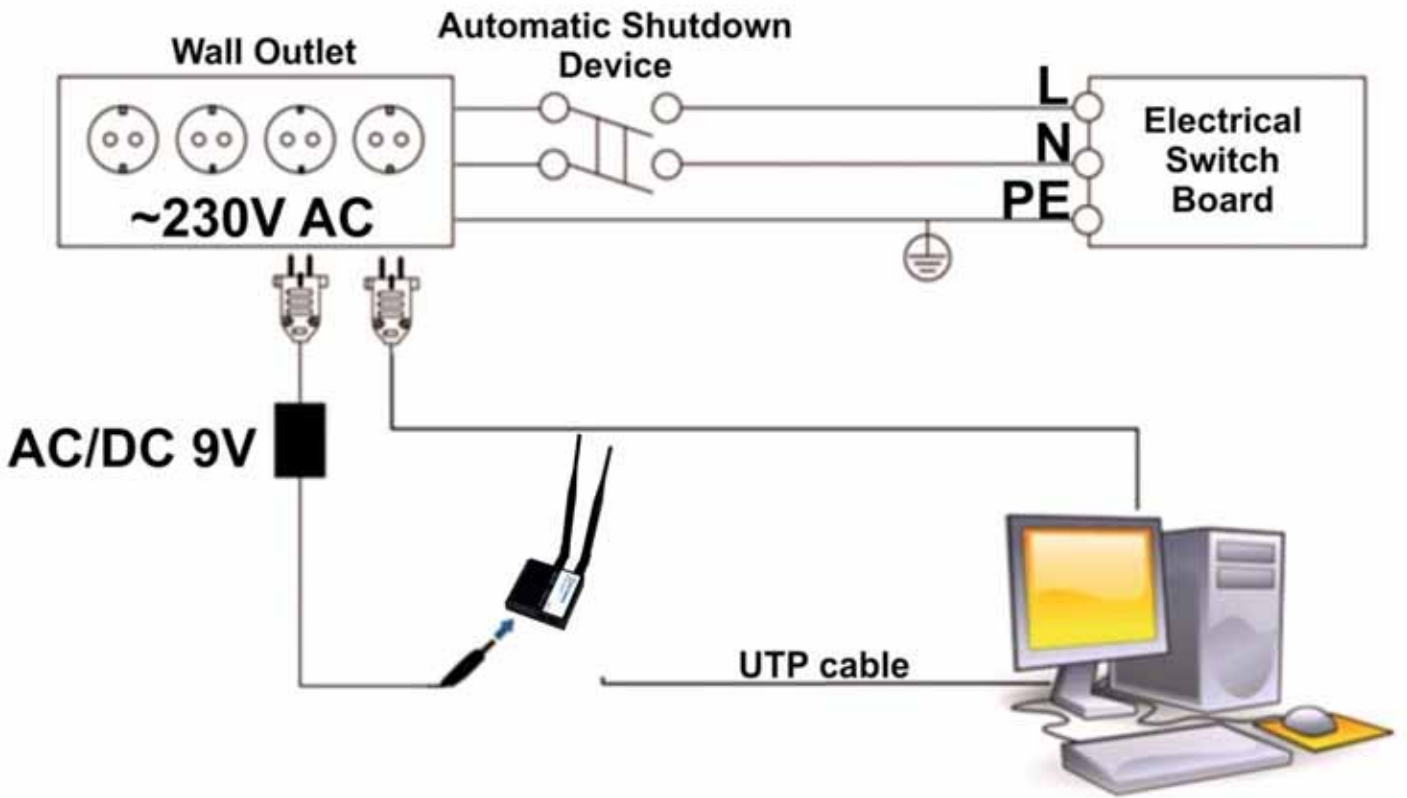

1 Introduction

Thank you for purchasing a RUT230 3G router!

RUT230 is part of the RUT2xx series of compact mobile routers with high speed wireless and Ethernet connections.

This router is ideal for people who would like to share their internet on the go, as it is not restricted by a cumbersome cable connection. Unrestricted, but not forgotten: the router still supports internet distribution via a broadband cable, simply plug it in to the wan port, set the router to a correct mode and you are ready to browse.

2 Specifications

2.1 Ethernet

- IEEE 802.3, IEEE 802.3u standards
- 1 x LAN 10/100Mbps Ethernet ports
- 1 x WAN 10/100Mbps Ethernet port
- Supports Auto MDI/MDIX

2.2 WiFi

- IEEE 802.11b/g/n WiFi standards
- AP and STA modes
- 64/128-bit WEP, WPA, WPA2, WPA&WPA2 encryption methods
- 2.401 – 2.495GHz WiFi frequency range
- 20dBm max WiFi TX power
- SSID stealth mode and access control based on MAC address

2.3 Hardware

- High performance 400 MHz CPU with 64 Mbytes of DDR2 memory
- External SIM holder
- Reset/restore to default button
- 1 x SMA for 3G , 1 x RP-SMA for WiFi antenna connectors
- 2 x Ethernet LEDs, 1 x Power LED
- 5 x signal LEDs, 2 x connection type indication LEDs
- Bottom and sideways DIN rail mounting slits

2.4 Electrical, Mechanical & Environmental

- Dimensions (H x W x D) 83mm x 74mm x 25mm
- Weight 125g

- Power supply 100 – 240 VAC -> 9 VDC wall adapter
- Input voltage range 9 – 30VDC
- Power consumption < 5W
- Operating temperature -40° to 75° C
- Storage temperature -45° to 80° C
- Operating humidity 10% to 90% Non-condensing
- Storage humidity 5% to 95% Non-condensing

2.5 Applications

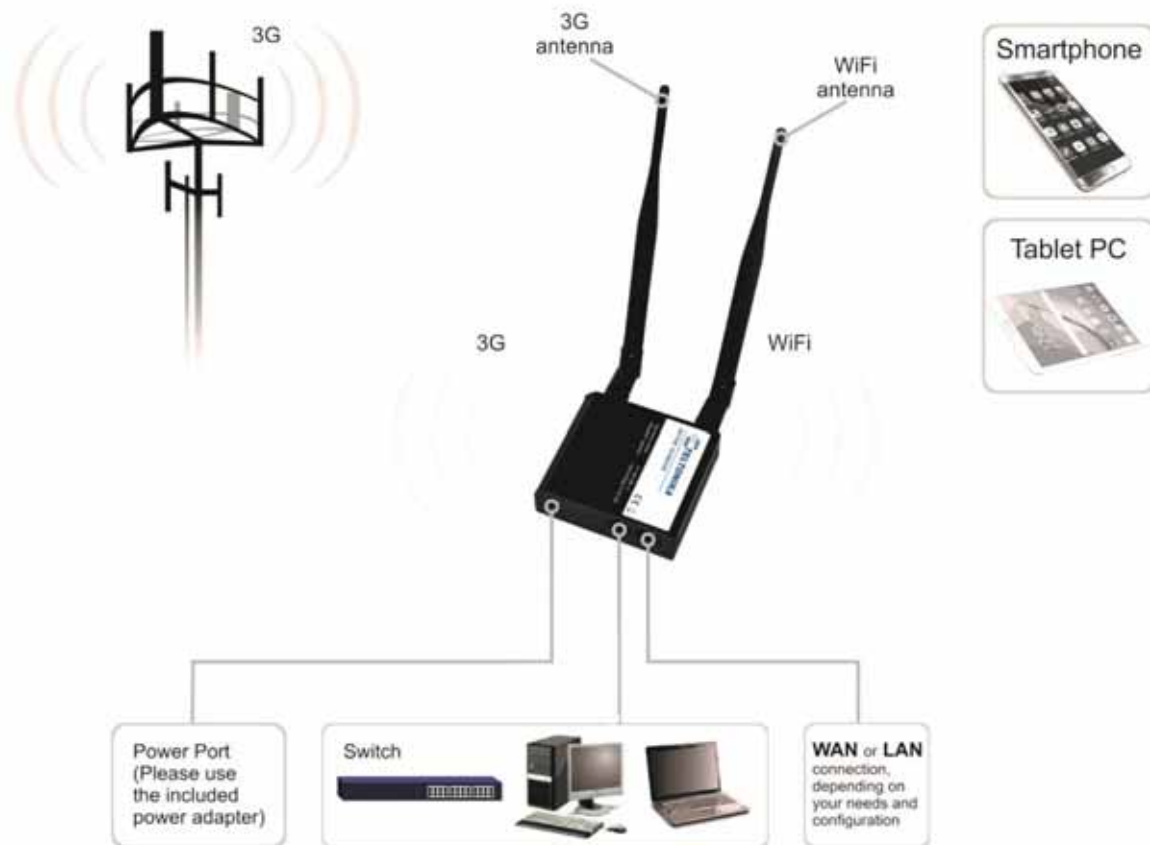

3 Setting up your router

3.1 Installation

After you unpack the box, follow the steps, documented below, in order to properly connect the device. For better WiFi performance, put the device in clearly visible spot, as obstacles such as walls and door hinder the signal.

1. First assemble your router by attaching the necessary antennas and inserting the SIM card.
2. To power up your router, please use the power adapter included in the box. (IMPORTANT: Using a different power adapter can damage and void the warranty for this product.).
3. If you have a wired broadband connection you will also have to connect it to the WAN port of the router.

3.1.1 Front Panel and Back Panel



1	LAN Ethernet ports
2	WAN/LAN Ethernet port
3	LAN LED
4	WAN LED
5	Power connector
6	Power LED
7	Signal strength indication LEDs
8	SIM card holder

1	WiFi antenna connector
2	3G main antenna connector
3	Reset button

3.1.2 Power connector

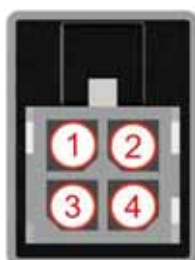

No.	Description	Wire color
1	Power	Red
2	Ground	Black
3	Input	Green
4	Output	White

3.1.3 Connection status LED

Explanation of connection status LED indication:

1. Signal strength status LED's turned on: router is turning on;

2. 2G and 3G LED's constant blinking every 1 sec: no SIM or bad PIN;
3. 2G/3G LED's blinking every 1 sec: connected 2G/3G, but no data session established;
4. Blinking from 2G LED to 3G LED repeatedly: SIM holder not inserted;
5. 2G/3G LED turned on: connected 2G/3G with data session;
6. 2G/3G LED blinking rapidly: connected 2G/3G with data session and data is being transferred.

3.1.4 Hardware installation

1. Insert SIM card which was given by your ISP (Internet Service Provider). Correct SIM card orientation is shown in the picture.

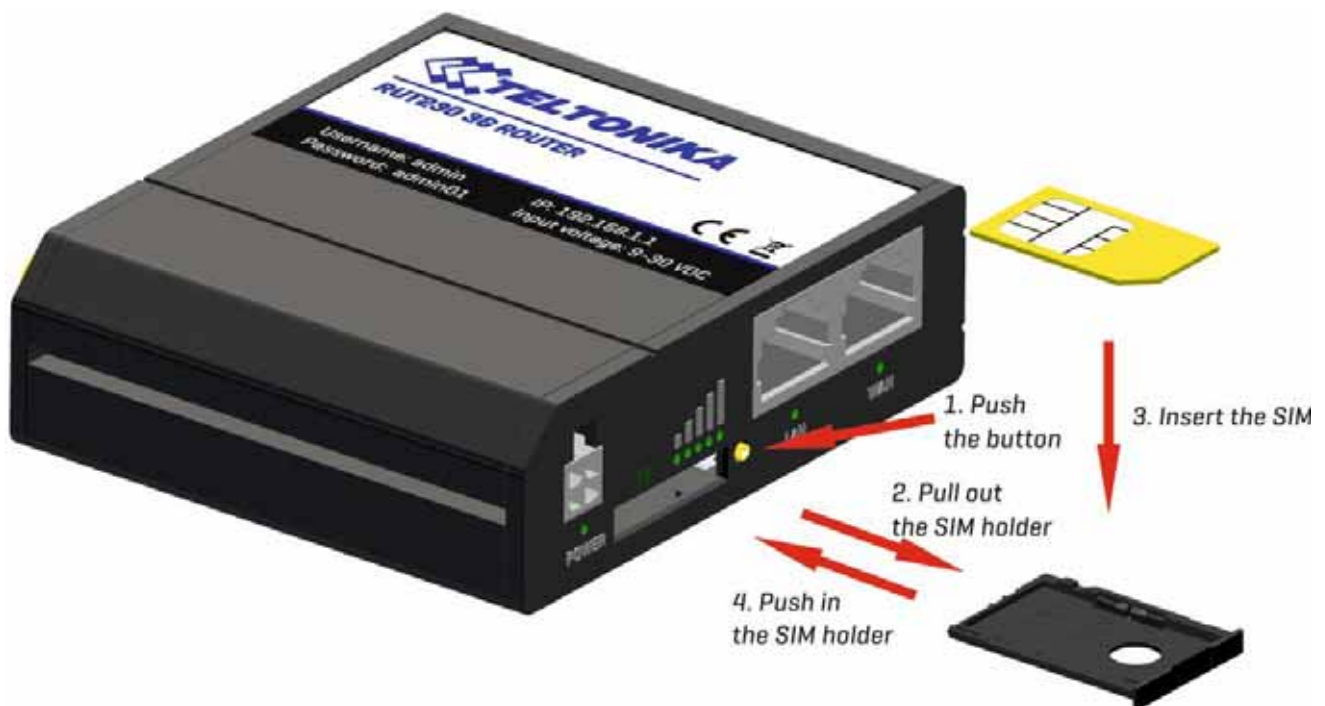

2. Attach 3G main and WiFi antennas.
3. Connect the power adapter to the socket on the front panel of the device. Then plug the other end of the power adapter into a wall outlet or power strip.
4. Connect to the device wirelessly (SSID: **Teltonika_Router**) or use Ethernet cable and plug it into any LAN Ethernet port.

3.2 Logging in

After you're complete with the setting up as described in the section above, you are ready to start logging into your router and start configuring it. This example shows how to connect on Windows 7. On windows Vista: click Start -> Control Panel -> Network and Sharing Center -> Manage network Connections -> (Go to step 4). On Windows XP: Click Start -> Settings -> Network Connections -> (see step 4). You won't see "Internet protocol version 4(TCP/IPv4)", instead you'll have to select "TCP/IP Settings" and click options -> (Go to step 6)

We first must set up our network card so that it could properly communicate with the router.

1. Press the start button

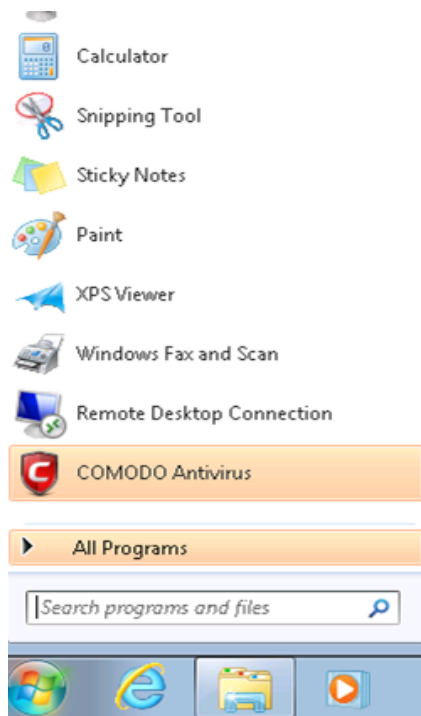

3. Click "View network connections"

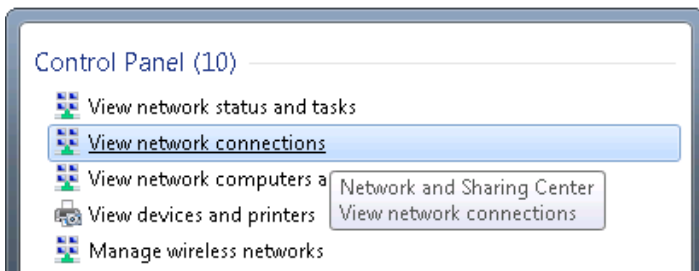

2. Type in "network connections", wait for the results to pop up.

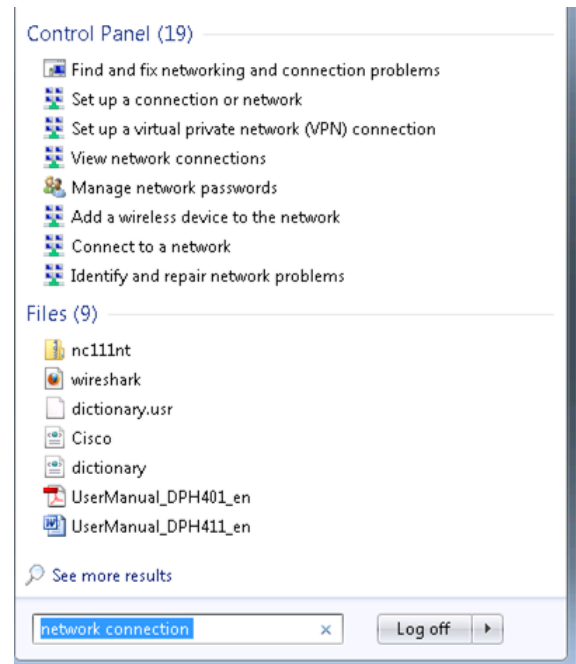

4. Then right click on your wireless device that you use to connect to other access points (It is the one with the name "Wireless Network Connection" and has signal bars on its icon).

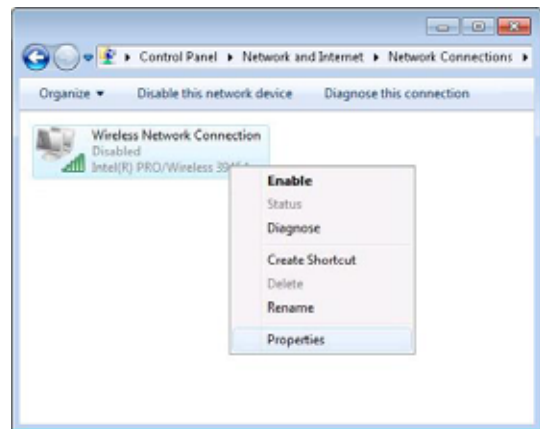

5. Select Internet Protocol Version 4 (TCP/IPv4) and then click Properties

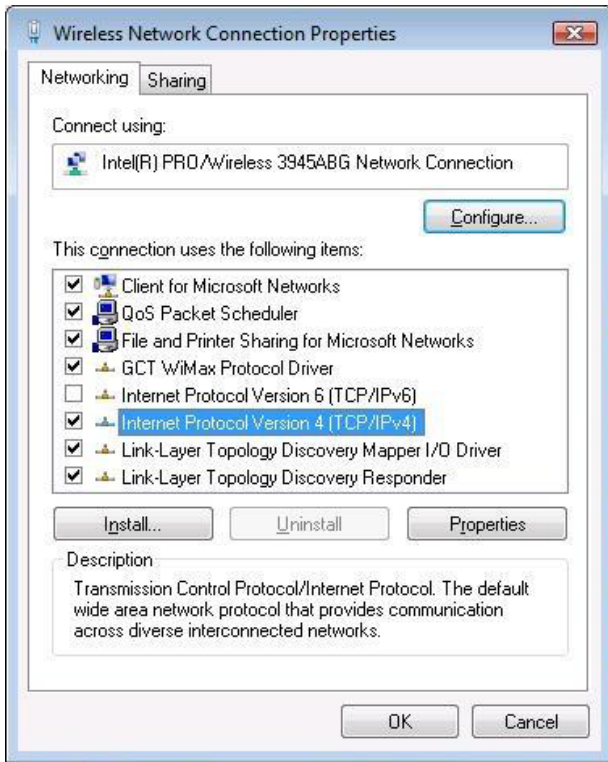

6. By default the router is going to have DHCP enabled, which means that if you select "Obtain an IP address automatically" and "Obtain DNS server address automatically", the router should lease you an IP and you should be ready to login.

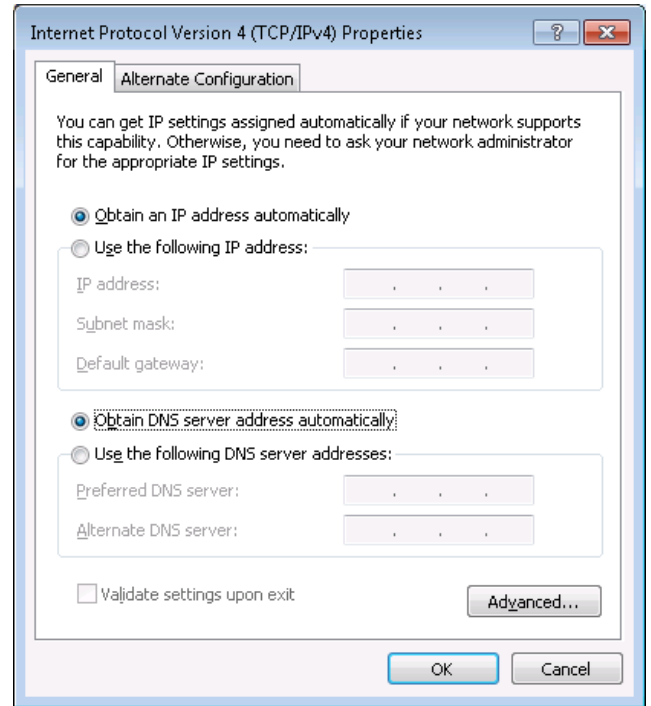

7. If you choose to configure manually here's what you have to do:

First select an IP address. Due to the stock settings that your router has arrived in you can only enter an IP in the form of 192.168.1.XXX , where XXX is a number in the range of 2-254 (192.168.1.2 , 192.168.1.254 , 192.168.1.155 and so on... are valid; 192.168.1.0 , 192.168.1.1 , 192.168.1.255 , 192.168.1.699 and so on... are not). Next we enter the subnet mask: this has to be "255.255.255.0". Then we enter the default gateway: this has to be "192.168.1.1". Finally we enter primary and secondary DNS server IP's. One will suffice, though it is good to have a secondary one as well as it will act as a backup if the first should fail. The DNS can be your routers IP (192.168.1.1), but it can also be some external DNS server (like the one Google provides: 8.8.8.8).

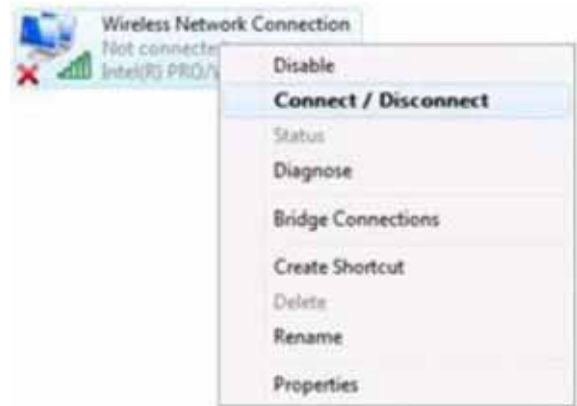
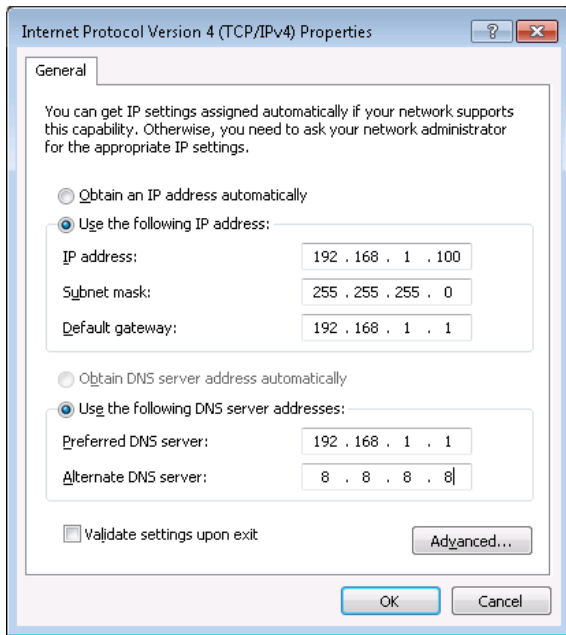

Right click on the Wireless network icon and select **Connect / Disconnect**. A list should pop up with all available wireless networks. Select “Teltonika” and click **connect**. Then we launch our favorite browser and enter the router’s IP into the address field:



Press enter. If there are no problems you should be greeted with a login screen such as this:

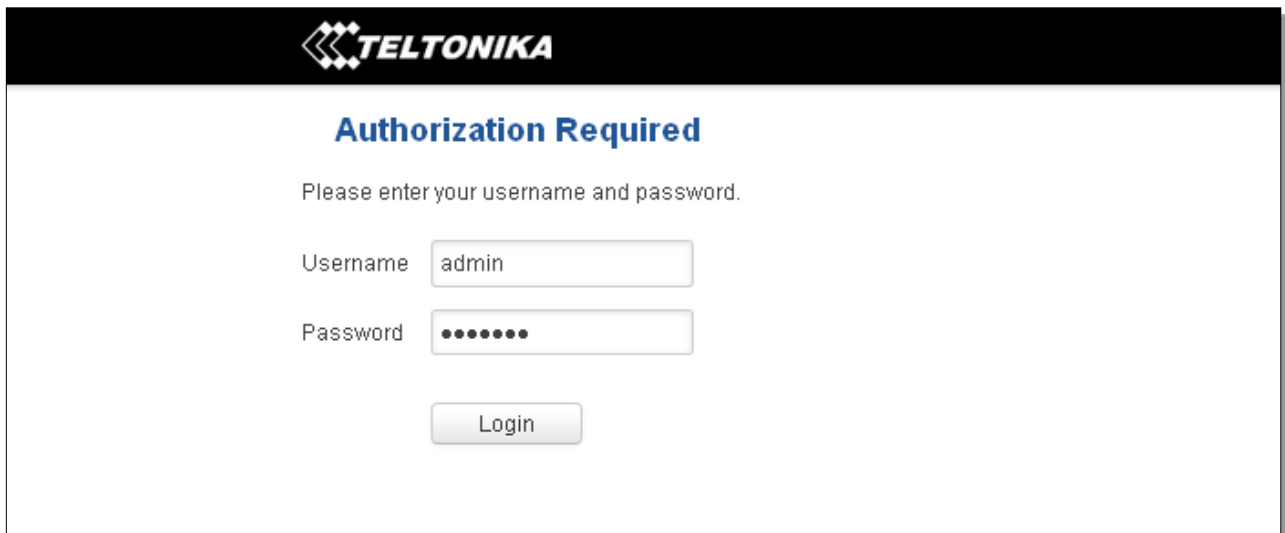

Enter the default password, which is “admin01” into the “Password” field and then either click Login with your mouse or press the Enter key. You have now successfully logged into the RUT230!

From here on out you can configure almost any aspect of your router.

4 Operation Modes

The RUT2xx series router supports various operation modes. It can be connected to the internet (WAN) via mobile, standard Ethernet cable or via a wireless network. When connecting to the internet, you may also backup your main WAN connection with one or two backup connections. Any interface can act like backup if configured so. At first router uses its main WAN connection, if it is lost then router tries to connect via backup with higher priority and if that fails too, router tries the second backup option.

Mobile	√	√	x
Ethernet	√	√	√
WiFi	√	√	√

In later sections it will be explained, in detail, how to configure your router to work in a desired mode.

5 Powering Options

The RUT2xx router can be powered from power socket

5.1 Powering the device from higher voltage

If you decide not to use our standard 9 VDC wall adapters and want to power the device from higher voltage (15 – 30 VDC), please make sure that you choose a power supply of high quality. Some power supplies can produce voltage peaks significantly higher than the declared output voltage, especially during connection.

While the device is designed to accept input voltage of up to 30 VDC, peaks from high voltage power supplies can harm the device. If you want to use high voltage power supplies it is recommended to also use additional safety equipment to suppress voltage peaks from the power supply.

6 Status



The status section contains various pieces of information, like current IP addresses of various network interfaces; the state of the routers memory; firmware version; DHCP leases; associated wireless stations; graphs indicating load, traffic and much more.



6.1 Overview

Overview section contains various information summaries.

TELTONIKA Status Network Services System Logout

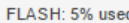
Overview

System ⓘ ⓘ	 19.0% CPU load	Mobile ⓘ ⓘ	-75 dBm 
Router uptime	0d 0h 53m 57s (since 2017-04-12, 13:41:36)	Data connection	Disconnected
Local device time	2017-04-12, 14:35:33	State	Registered (home); LT BITE GSM; 3G (HSDPA+HSUPA)
Memory usage	RAM: 76% used  FLASH: 5% used 	SIM card status	SIM (Ready)
Firmware version	RUT2XX_T_00.00.136	Bytes received/sent *	0 B / 0 B

Wireless ⓘ ⓘ	ON 	WAN ⓘ ⓘ	Wired 
SSID	🔒 HAL9000 (AP)	IP address	192.168.1.202
Mode	1- AP; 11 CH (2.462 GHz)	Backup WAN status	Backup link is disabled

Local Network ⓘ ⓘ		Access Control ⓘ ⓘ	
IP / netmask	192.168.200.1 / 255.255.255.0	LAN	SSH; HTTP; HTTPS
Clients connected	2	WAN	No access

Recent System Events ⓘ ⓘ		Recent Network Events ⓘ ⓘ	
1 2017-04-12 14:23:50 - DHCP: Leased 192.168.200.157 IP address ...		1 2017-04-12 14:23:53 - WiFi client connected: C0:11:73:94:E8:E5 ...	
2 2017-04-12 14:13:40 - Web UI: Authentication was succesful fro ...		2 2017-04-12 14:22:51 - WiFi client disconnected: C0:11:73:94:E8 ...	
3 2017-04-12 14:04:06 - DHCP: Leased 192.168.200.124 IP address ...		3 2017-04-12 14:06:18 - Connected to LT BITE GSM operator	
4 2017-04-12 14:04:00 - DHCP: Leased 192.168.200.157 IP address ...		4 2017-04-04 09:55:27 - WiFi client connected: C0:11:73:94:E8:E5 ...	

* Your carrier's data usage accounting may differ. Teltonika is not liable should any accounting discrepancies occur.

Teltonika solutions www.teltonika.it

6.2 System Information

The System Information tab contains data that pertains to the routers operating system.

TELTONIKA
Status ▾ Network ▾ Services ▾ System ▾
Logout

System Information

System	
Router name	RUT230
Host name	Teltonika-RUT230.com
Router model	?
Firmware version	RUT2XX_T_00.00.136
Kernel version	3.18.44
Bootloader version	1.0.0
Local device time	2017-04-12, 14:41:18
Uptime	0d 0h 59m 42s (since 2017-04-12, 13:41:36)
Load average	1 min: 5%; 5 mins: 72%; 15 mins: 76%
Temperature	40° C

Memory	
Free	14924 kB / 61020 kB (24%)
Cached	16992 kB / 61020 kB (27%)
Buffered	6740 kB / 61020 kB (11%)

System explanation:

	Field Name	Sample value	Explanation
1.	Router Name	RUT230	Name of the router (hostname of the router's system). Can be changed in System -> Administration.
2.	Host name	Teltonika-RUT230.com	Indicates how the router will be seen by other devices on the network. Can be changed in System -> Administration.
3.	Router Model	Teltonika RUT230 3G	Router's model.
4.	Firmware Version	RUT2XX_T_00.00.136	Shows the version of the firmware that is currently loaded in the router. Newer versions might become available as new features are added. Use this field to decide whether you need a firmware upgrade or not.
5.	Kernel Version	3.18.44	The version of the Linux kernel that is currently running on the router.
6.	Local Time	2017-04-12, 14:41:18	Shows the current system time. Might differ from your computer, because the router synchronizes its time with an NTP server. Format [year-month-day, hours: minutes: seconds].

7.	Uptime	0d 0h 59m 42s (since 2017-04-12, 13:41:36)	Indicates how long it has been since the router booted up. Reboots will reset this timer to 0. Format [days hours minutes seconds (since year-month-day, hours: minutes: seconds)].
8.	Load Average	1 min: 5%; 5 mins: 72%; 15 mins: 76%	Indicates how busy the router is. Let's examine some sample output: "1 min: 5%, 5 mins: 72%, 15 mins: 76%". The first number means past minute and the second number 5 means that in the past minute there have been, on average, 5% processes running or waiting for a resource.
9.	Temperature	40° C	Device's temperature

Memory explanation:

	Field Name	Sample Value	Explanation
1.	Free	14924 kB / 61020 kB (24%)	The amount of memory that is completely free. Should this rapidly decrease or get close to 0, it would indicate that the router is running out of memory, which could cause crashes and unexpected reboots.
2.	Cached	16992 kB / 61020 kB (27%)	The size of the area of memory that is dedicated to storing frequently accessed data.
3.	Buffered	6740 kB / 61020 kB (11%)	The size of the area in which data is temporarily stored before moving it to another location.

6.3 Network Information

6.3.1.1 Mobile

Displays information about mobile modem connections.

TELTONIKA Status Network Services System Logout

Mobile WAN LAN Wireless OpenVPN VRRP Access

Mobile Information

Mobile

Data connection state	Connected
IMEI	861075024498503
IMSI	246020100944448
ICCID	8937002160600414481F
Sim card state	Ready
Signal strength	-69 dBm
Cell ID	6900156
RSCP	N/A
Ec/Io	N/A
Operator	LT BITE GSM
Operator state	Registered (home)
Connection type	3G (HSDPA+HSUPA)
Bytes received *	58.1 KB (59466 bytes)
Bytes sent *	47.8 KB (48938 bytes)

Reboot modem Restart connection (Re)register Refresh

*Your carrier's data usage accounting may differ. Teltonika is not liable should any accounting discrepancies occur.

Mobile information:

	Field Name	Sample Value	Explanation
1.	Data connection state	Connected	Mobile data connection status
2.	IMEI	861075024498503	Modem's IMEI (International Mobile Equipment Identity) number
3.	IMSI	246020100944448	IMSI (International Mobile Subscriber Identity) is used to identify the user in a cellular network
4.	ICCID	8937002160600414481F	Your SIM card's Integrated circuit card identifier number
5.	SIM card state	Ready	Indicates the SIM card's state, e.g. PIN required, Not inserted, etc.
6.	Signal strength	-69 dBm	Received Signal Strength Indicator (RSSI). Signal's strength measured in dBm
7.	Cell ID	6900156	ID of operator cell that device is currently connected to
8.	RSCP	N/A	Indicates the Reference Signal Received Power
9.	Ec/Io	N/A	Indicates the Reference Signal Received Quality
10.	Operator	LT BITE GSM	Operator's name of the connected GSM network
11.	Operator state	Registered (home)	GSM network's status
12.	Connection type	3G (HSDPA+HSUPA)	Indicates the GSM network's access technology
13.	Bytes received	58.1 KB (59466 bytes)	How many bytes were received via mobile data connection
14.	Bytes sent	47.8 KB (48939 bytes)	How many bytes were sent via mobile data connection

6.3.1.2 WAN

Displays information about WAN connection.

WAN Information

WAN

Interface	Wired
Type	DHCP
IP address	192.168.1.202
WAN MAC	00:1E:42:00:02:1E
Netmask	255.255.255.0
Gateway	192.168.1.1
DNS 1	192.168.1.1
Connected	0h 1m 5s

Ports



WAN information:

	Field Name	Sample Value	Explanation
1.	Interface	Wired	Specifies through what medium the router is connecting to the internet. This can either be Wired, Mobile or WiFi.
2.	Type	DHCP	Specifies the type of connection. This can either be static or DHCP.
3.	IP address	192.168.1.202	The IP address that the router uses to connect to the internet.
4.	WAN MAC	00:1E:42:00:02:1E	MAC (Media Access Control) address used for communication in an Ethernet WAN (Wide Area Network)
5.	Netmask	255.255.255.0	Specifies a mask used to define how large the WAN network is
6.	Gateway	192.168.1.1	Indicates the default gateway, an address where traffic destined for the internet is routed to.
7.	DNS 1	192.168.1.1	Domain name server(s).
8.	Connected	0h 1m 5s	How long the connection has been successfully maintained.

6.3.1.3 LAN

Displays information about LAN connections.

The screenshot shows the Teltonika web interface with the following sections:

- Navigation:** TELTONIKA logo, Status, Network, Services, System, and Logout.
- Menu:** Mobile, WAN, LAN (selected), Wireless, OpenVPN, VRRP, Access.
- LAN Information:**

Name	IP address	Netmask	Ethernet MAC address	Connected for
Lan	192.168.200.1	255.255.255.0	00:1E:42:00:02:1D	1h 37m 25s
- DHCP Leases:**

Hostname	IP address	LAN name	MAC address	Lease time remaining
DESKTOP-69EIUGN	192.168.200.124	Lan	18:66:DA:28:6A:34	11h 52m 58s
android-2450c1993f706ced	192.168.200.157	Lan	C0:11:73:94:E8:E5	11h 4m 1s
- Ports:** A diagram of a router showing POWER, LAN, and WAN ports. The LAN port is lit green, and the WAN port has a red X over it.
- Refresh:** A button with a circular arrow icon.

LAN information:

	Field Name	Sample Value	Explanation
1.	Name	Lan	LAN instance name
2.	IP address	192.168.200.1	Address that the router uses on the LAN network.
3.	Netmask	255.255.255.0	A mask used to define how large the LAN network is
4.	Ethernet MAC address	00:1E:42:00:02:1D	MAC (Media Access Control) address used for communication in an Ethernet LAN (Local Area Network)
5.	Connected for	1h 37m 25s	How long the LAN has been successfully maintained.

DHCP Leases

If you have enabled a DHCP server this field will show how many devices have received an IP address and what those IP addresses are.

	Field Name	Sample Value	Explanation
1.	Hostname	DESKTOP69-EIUGN	DHCP client's hostname
2.	IP address	192.168.200.124	Each lease declaration includes a single IP address that has been leased to the client
3.	LAN name	Lan	LAN instance name
4.	MAC address	18:66:DA:28:6A:34	The MAC (Media Access Control) address of the network interface on which the lease will be used. MAC is specified as a series of hexadecimal octets separated by colons
5.	Lease time remaining	11h 52m 58s	Remaining lease time for addresses handed out to clients

6.3.1.4 Wireless

Wireless can work in two modes, Access Point (AP) or Station (STA). AP is when the wireless radio is used to create an Access Point that other devices can connect to. STA is when the radio is used to connect to an Access Point via WAN.

6.3.1.4.1 Station

The screenshot shows the Teltonika web interface with the following structure:

- Navigation Bar:** TELTONIKA logo, Status, Network, Services, System, and Logout.
- Menu:** Mobile, WAN, LAN, **Wireless**, OpenVPN, VRRP, Access.
- Section Header:** Wireless Information
- Wireless Information Table:**

Channel	1 (2.41 GHz)
Country code	00 (World)
- Wireless Status Table:**

SSID	Mode	Encryption	Wireless MAC	Signal quality	Bit rate
GG	Station (STA)	WPA2 PSK (CCMP)	C0:11:73:94:E8:E5	100%	39.0 MBit/s
Teltonika_Router	Access Point (AP)	mixed WPA/WPA2 PSK (CCMP)	02:1E:42:00:02:1F	0%	N/A
- Associated Stations Table:**

MAC address	Device name	Signal	RX rate	TX rate
C0:11:73:94:E8:E5	android-2450c1993f706ced	-30 dBm	58.5 Mbit/s, MCS 6, 20MHz	39.0 Mbit/s, MCS 4, 20MHz
- Refresh Button:** Refresh

Display information about wireless connection (Station mode).

Client mode information

	Item Name	Sample Value	Explanation
1.	Channel	1 (2.41 GHz)	The channel that the AP, to which the router is connected to, uses. Your wireless radio is forced to work in this channel in order to maintain the connection.
2.	Country code	00 (World)	Country code.
3.	SSID	GG	The SSID that the AP, to which the router is connected to, uses.
4.	Mode	Station (STA)	Connection mode – Station (STA) indicates that the router is a client to some local AP.
5.	Encryption	WPA2 PSK (CCMP)	The AP, to which the router is connected to, dictates the type of encryption.
6.	Wireless MAC	C0:11:73:94:E8:E5	The MAC address of the access points radio.
7.	Signal Quality	100%	The quality between routers radio and some other device that is connecting to the router. Will show 0% if no devices are trying to connect or are currently maintaining a connection.
8.	Bit rate	39.0 MBit/s	The physical maximum possible throughput that the routers radio can handle. Keep in mind that this value is cumulative - The bit rate will be shared between the router and other possible devices that connect to the local AP.

6.3.1.4.2 Access Point

Display information about wireless connection (Access Point mode).

The screenshot shows the Teltonika web interface with the 'Wireless' tab selected. The 'Wireless Information' section displays Channel 1 (2.41 GHz) and Country code 00 (World). The 'Wireless Status' table shows SSID RUT200_test, Mode Access Point (AP), Encryption mixed WPA/WPA2 PSK (CCMP), Wireless MAC 00:1E:42:00:02:1F, Signal quality 100%, and Bit rate 52.0 MBit/s. The 'Associated Stations' table shows one device with MAC address C0:11:73:94:E8:E5, Device name android-2450c1993f706ced, Signal -42 dBm, RX rate 72.2 Mbit/s, MCS 7, 20MHz, and TX rate 52.0 Mbit/s, MCS 5, 20MHz. A Refresh button is located at the bottom right.

Wireless AP information

	Field Name	Sample Value	Explanation
1.	Channel	1 (2.41 GHz)	The channel which is used to broadcast the SSID and to establish new connections to devices.
2.	Country code	00(World)	Country code.
3.	SSID	RUT200_test	The SSID that is being broadcast. Other devices will see this and will be able to use to connect to your wireless network.
4.	Mode	Access Point (AP)	Connection mode – Access Point (AP) indicates that your router is an access point.
5.	Encryption	Mixed WPA/WPA2 PSK (CCMP)	The type of encryption that the router will use to authenticate, establish and maintain a connection.
6.	Wireless MAC	00:1E:42:00:02:1F	MAC address of your wireless radio.
7.	Signal Quality	000%	The quality between routers radio and some other device that is connecting to the router. Will show 0% if no devices are trying to connect or are currently maintaining a connection.
8.	Bit rate	52.0 Mbit/s	The bit rate will be shared between all devices that connect to the routers wireless network.

Additional note: MBit/s indicates the bits not bytes. To get the throughput in bytes divide the bit value by 8, for e.g. 54Mbits/s would be 6.75MB/s (Mega Bytes per second).

6.3.1.5 Associated Stations

Outputs a list of all devices and their MAC addresses that are maintain a connection with your router right now.

This can either be the information of the Access Point that the router is connecting to in STA mode or a list of all devices that are connecting to the router in AP mode:

	Field Name	Sample Value	Explanation
1.	MAC Address	C0:11:73:94:E8:E5	Associated station's MAC (Media Access Control) address
2.	Device Name	android-2450c1993f706ced	DHCP client's hostname
3.	Signal	-42dBm	Received Signal Strength Indicator (RSSI). Signal's strength measured in dBm
4.	RX Rate	72.2Mbit/s, MCS 7, 20MHz	The rate at which packets are received from associated station
5.	TX Rate	52.0Mbit/s, MCS 5, 20MHz	The rate at which packets are sent to associated station

6.3.1.6 OpenVPN Client

Displays OpenVPN connection information on client side.

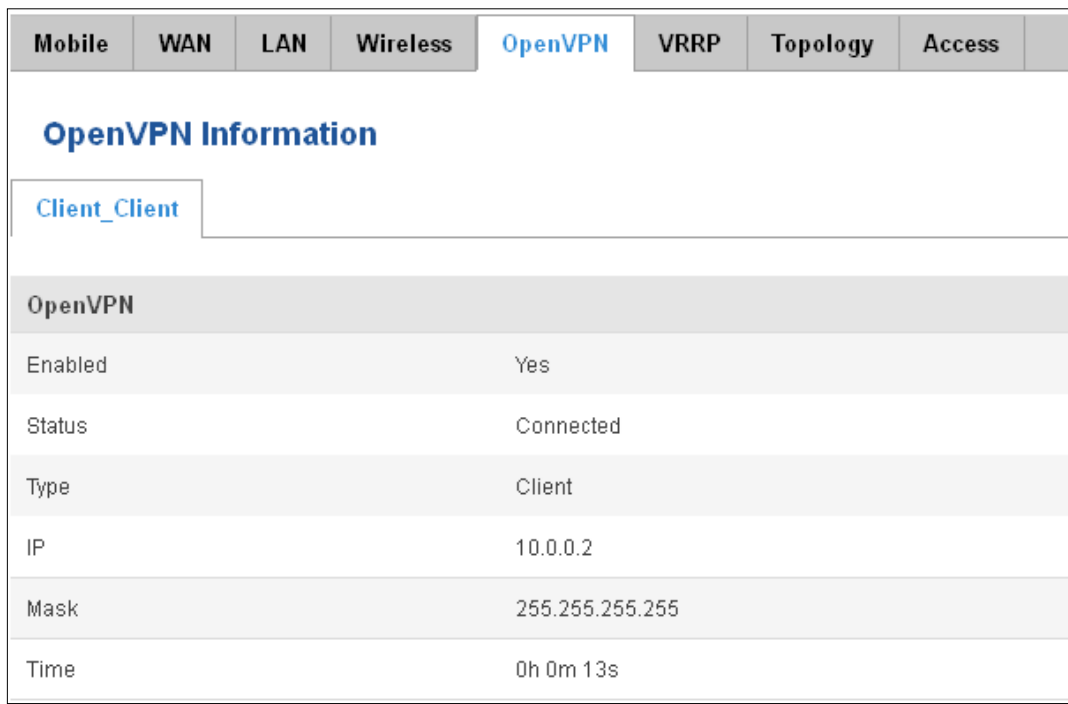

Mobile	WAN	LAN	Wireless	OpenVPN	VRRP	Topology	Access
OpenVPN Information							
Client_Client							
OpenVPN							
Enabled		Yes					
Status		Connected					
Type		Client					
IP		10.0.0.2					
Mask		255.255.255.255					
Time		0h 0m 13s					

	Field Name	Sample Value	Explanation
1.	Enabled	Yes/No	OpenVPN status
2.	Status	Connected	Connection status
3.	Type	Client	A type of OpenVPN instance that has been created
4.	IP	10.0.0.2	Remote virtual network's IP address
5.	Mask	255.255.255.255	Remote virtual network's subnet mask
6.	Time	0h 0m 13s	For how long the connection has been established

6.3.1.7 OpenVPN Server

Display OpenVPN connection information on server side.

Mobile	WAN	LAN	Wireless	OpenVPN	VRRP	Topology	Access
OpenVPN Information							
Server_Server							
OpenVPN							
Enabled	Yes						
Status	Connected						
Type	Server						
IP	10.0.0.1						
Mask	255.255.255.255						
Time	0h 6m 31s						
Clients Information							
Common Name	Real Address	Virtual Address	Connection Since				
Test001	212.59.13.226:52638	10.0.0.6	Thu May 05 2016 07:46:29 GMT+0300 (FLE Standard Time)				

No.	Parameter	Value	Description
1.	Enabled	Yes/No	OpenVPN status
2.	Status	Connected	Connection status
2.	Type	Server	A type of OpenVPN instance that has been created
3.	IP	10.0.0.1	Remote virtual network's IP address
4.	Mask	255.255.255.255	Remote virtual network's subnet mask
5.	Time	0h 6m 31s	How long the connection has been established

6.3.1.8 Clients information

It will show information, when router is configured as OpenVPN TLS server.

No.	Parameter	Value	Description
1.	Common Name	Test001	OpenVPN client's name
2.	Real Address	212.59.13.226:52638	Client's IP address and port number
3.	Virtual Address	10.0.0.6	The virtual address that has been given to a client
4.	Connection Since	Thu May 05 2016 07:46:29 GMT + 0300 (FLE Standard Time)	Since when the connection has been established

6.3.1.9 VRRP

VRRP (Virtual Router Redundancy Protocol) for LAN

Mobile	WAN	LAN	Wireless	OpenVPN	VRRP	Topology	Access
VRRP Information							
VRRP LAN Status							
Status				Enabled			
Virtual ip				192.168.1.253			
Priority				100			
Router				Master			
							Refresh

	Field Name	Field Value	Explanation
1.	Status	Enabled	VRRP status
2.	Virtual IP	192.168.1.253	Virtual IP address(-es) for LAN's VRRP (Virtual Router Redundancy Protocol) cluster
3.	Priority	100	Router with the highest priority value on the same VRRP cluster will act as a master, range [1 - 255]
4.	Router**	Master	Connection mode – Master

**-Exclusive to other Modes with Slave.

6.3.1.10 Access

Display information about local and remote active connections status.

Mobile	WAN	LAN	Wireless	OpenVPN	VRRP	Topology	Access
Access Status							
Access information		Last Connections					
Local Access							
Type	Status	Port	Active Connections				
SSH	Enabled	22	0 (0.00 B)				
HTTP	Enabled	80	1 (9.26 KB)				
HTTPS	Enabled	443	0 (0.00 B)				
Remote Access							
Type	Status	Port	Active Connections				
SSH	Disabled	22	0 (0.00 B)				
HTTP	Disabled	80	0 (0.00 B)				
HTTPS	Enabled	443	6 (558.12 KB)				
							Refresh

	Field Name	Sample Value	Explanation
1.	Type	SSH; HTTP; HTTPS	Type of connection protocol
2.	Status	Disabled/Enabled	Connection status
3.	Port	22; 80; 443	Connection port used
4.	Active Connections	0(0.00B);0(0.00B); 6(558.12 KB)	Count of active connections and the amount of data transmitted in KB

6.3.1.10.1 Last Connections

Displays information about the last 3 local and remote connections

Access Status			
Access Information		Last Connections	
Last Local Connections			
Type	Date	IP	Authentications Status
SSH	2016-03-03, 13:40:59	192.168.2.10	Succeeded
	2016-03-03, 13:47:44	192.168.2.10	Succeeded
	2016-03-09, 08:59:41	192.168.1.214	Succeeded
HTTP	2016-03-09, 08:30:04	192.168.1.214	Succeeded
	2016-03-09, 13:52:08	192.168.1.214	Succeeded
	2016-03-09, 08:26:16	192.168.1.214	Succeeded
HTTPS	<i>There are no records yet.</i>		
Last Remote Connections			
Type	Date	IP	Authentications Status
SSH	2016-03-07, 07:57:51	212.59.13.226	Succeeded
	2016-03-07, 08:41:46	119.167.153.187	Failed
	2016-03-07, 08:41:55	119.167.153.187	Failed
HTTP	2016-03-07, 07:56:06	10.8.32.1	Succeeded
	2016-03-07, 07:57:15	212.59.13.226	Succeeded
	2016-03-09, 14:13:05	10.8.32.1	Succeeded
HTTPS	<i>There are no records yet.</i>		

	Field Name	Sample Value	Explanation
1.	Type	SSH; HTTP; HTTPS	Type of connection protocol
2.	Date	2016-03-03, 13:40:59	Date and time of connection
3.	IP	192.168.2.10	IP address from which the connection was made
4.	Authentications Status	Failed/Succeed	Status of authentication attempt

6.4 Device information



The page displays factory information that was written into the device during manufacturing process.

TELTONIKA		Status ▾	Network ▾	Services ▾	System ▾	Logout
Device Information						
Device						
Serial number	77885555					
Product code	RUT900001000					
Batch number	1000					
Hardware revision	0001					
IMEI	351579053257484					
IMSI	246021003515790					
Ethernet LAN MAC address	00:1E:42:00:00:1E					
Ethernet WAN MAC address	00:1E:42:00:00:11					
Wireless MAC address	00:1E:42:00:00:12					
Modem						
Model	HE910-D					
FW version	12.00.027					

1.	Serial number	77885555	Serial number of the device
2.	Product code	RUT900001000	Product code of the device
3.	Batch number	1000	Batch number used during the device's manufacturing process
4.	Hardware revision	0001	Hardware revision of the device
5.	IMEI	351579053257484	Identification number of the internal modem
6.	IMSI	246021003515790	Subscriber identification number of the internal modem
6.	Ethernet LAN MAC	00:1E:42:00:00:1E	MAC address of the Ethernet LAN ports
7.	Ethernet WAN MAC	00:1E:42:00:00:11	MAC address of the Ethernet WAN port
8.	Wireless MAC	00:1E:42:00:00:12	MAC address of the WiFi interface
9.	Model	HE910-D	Router's modem model
10.	FW version	12.00.027	Router's modem firmware version

6.5 Services

The page displays the usage of the available services.

Status ▾ Network ▾ Services ▾ System ▾ Logout 

Services

Services Status

VRRP LAN	Disabled	Restart	DDNS	Disabled	Restart
OpenVPN servers	Disabled	Restart	Site blocking	Disabled	Restart
OpenVPN clients	Disabled	Restart	Content blocker	Disabled	Restart
SNMP agent	Disabled	Restart	SMS utils rules	Enabled	Restart
SNMP trap	Disabled	Restart	Hotspot	Disabled	Restart
NTP client	Enabled	Restart	Hotspot logging	Disabled	Restart
IPsec	Disabled	Restart	GRE tunnel	Disabled	Restart
Ping reboot	Disabled	Restart	QoS	Disabled	Restart
Input/Output rules	Disabled	Restart			

Refresh 

6.6 Routes

The page displays ARP table and active IP routes of the device.

6.6.1 ARP

Show the router's active ARP table. An ARP table contains recently cached MAC addresses of every immediate device that was communicating with the router.

ARP		
IP Address	MAC Address	Interface
10.0.207.217	02:50:F3:00:00:00	eth2
192.168.99.17	00:25:22:D7:CA:A7	br-lan
192.168.99.36	38:2C:4A:64:2D:E5	br-lan
192.168.99.155	00:00:00:00:00:00	br-lan

1.	IP Address	192.168.99.17	Recently cached IP addresses of every immediate device that was communicating with the router
2.	MAC Address	00:25:22:D7:CA:A7	Recently cached MAC addresses of every immediate device that was communicating with the router
3.	Interface	br-lan	Interface used for connection

6.6.2 Active IP-Routes

Shows the router's routing table. The routing table indicates where a TCP/IP packet, with a specific IP address, should be directed to.

Active IP Routes			
Network	Target	IP Gateway	Metric
ppp	0.0.0.0/0	10.0.207.217	0
ppp	10.0.207.216/29	0.0.0.0	0
ppp	10.0.207.217	0.0.0.0	0
lan	192.168.99.0/24	0.0.0.0	0

1.	Network	ppp	Interface to be used to transmit TCP/IP packets through
2.	Target	192.168.99.0/24	Indicates where a TCP/IP packet, with a specific IP address, should be directed
3.	IP Gateway	0.0.0.0	Indicates through which gateway a TCP/IP packet should be directed
4.	Metric	0	Metric number indicating interface priority of usage

6.6.3 Active IPv6-Routes

Display active IPv6 routes for data packet transition.

Active IPv6-Routes			
Network	Target	IPv6-Gateway	Metric
loopback	0:0:0:0:0:0:0:0/0	0:0:0:0:0:0:0:0/0	FFFFFFFF
loopback	0:0:0:0:0:0:0:0/0	0:0:0:0:0:0:0:0/0	FFFFFFFF
loopback	0:0:0:0:0:0:0:1	0:0:0:0:0:0:0:0/0	00000000
ppp	FF00:0:0:0:0:0:0:0/8	0:0:0:0:0:0:0:0/0	00000100
loopback	0:0:0:0:0:0:0:0/0	0:0:0:0:0:0:0:0/0	FFFFFFFF

1.	Network	loopback	Network interface used
2.	Target	0:0:0:0:0:0:0:0/0	Indicates where a TCP/IP packet, with a specific IP address, should be directed
3.	IPv6-Gateway	0:0:0:0:0:0:0:0/0	Indicates through which gateway a TCP/IP packet should be directed
4.	Metric	FFFFFFFF	Metric number indicating interface priority of usage

6.7 Graphs

Real-time graphs show how various statistical data changes over time.

6.7.1 Mobile Signal Strength

Displays mobile signal strength variation in time (measured in dBm)

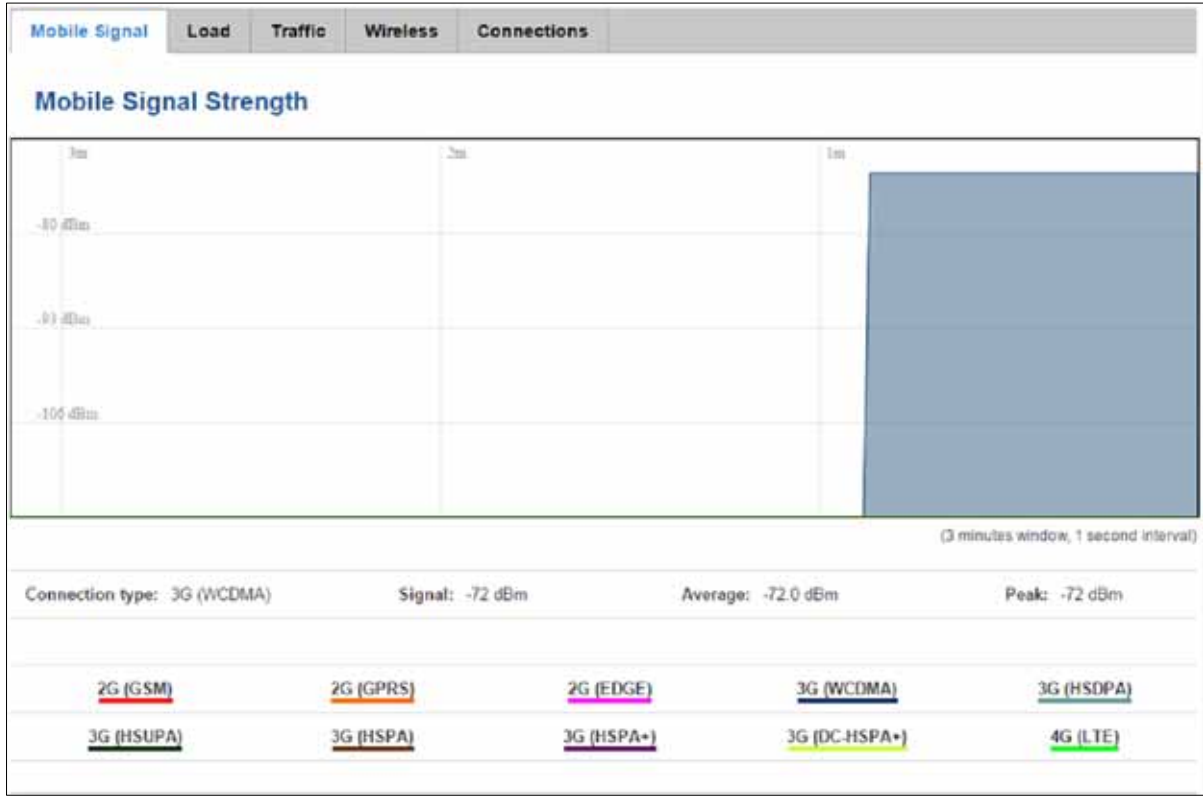

1.	Connection type	3G (WCDMA)	Type of mobile connection used
2.	Signal	-72 dBm	Current signal strength value
3.	Average	-72.0 dBm	Average signal strength value
4.	Peak	-72 dBm	Peak signal strength value

6.7.2 Realtime Load

This tri-graph illustrates average CPU load values in real time. The graph consists out of three color coded graphs, each one corresponding to the average CPU load over 1 (red), 5 (orange) and 15 (yellow) most recent minutes.



1.	1/5/15 Minutes Load	0.83	Time interval for load averaging, colour of the diagram
2.	Average	0.86	Average CPU load value over time interval (1/5/15 Minute)
3.	Peak	1.50	Peak CPU load value of the time interval

6.7.3 Realtime Traffic

These graphs illustrate the average system inbound and outbound traffic over the course of 3 minutes; each new measurement is taken every 3 seconds. Each graph consists out of two color coded graphs (green graph shows the outbound traffic, blue graph shows the inbound traffic). Although not graphed, the page also displays peak loads and averages of inbound and outbound traffic.

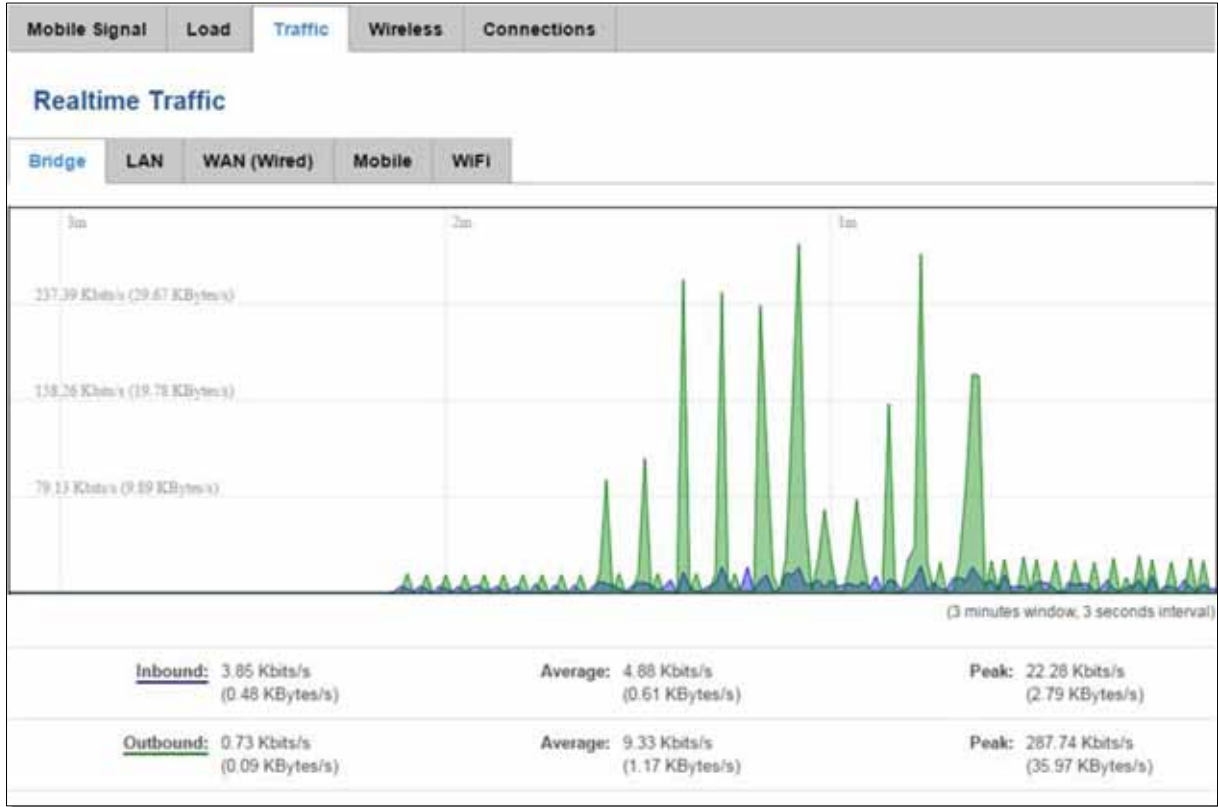

1.	Bridge	Cumulative graph, which encompasses wired Ethernet LAN and the wireless network.
2.	LAN	Graphs the total traffic that passes through both LAN network interfaces.
3.	WAN (Wired)	Graphs the amount of traffic which passed through the current active WAN connection.
4.	Mobile	Graphs the amount of traffic which passed through the mobile network connection.
5.	WiFi	Shows the amount of traffic that has been sent and received through the wireless radio.

6.7.4 Realtime Wireless

Displays the wireless radio signal, signal noise and the theoretical maximum channel permeability. Average and peak signal levels are displayed.

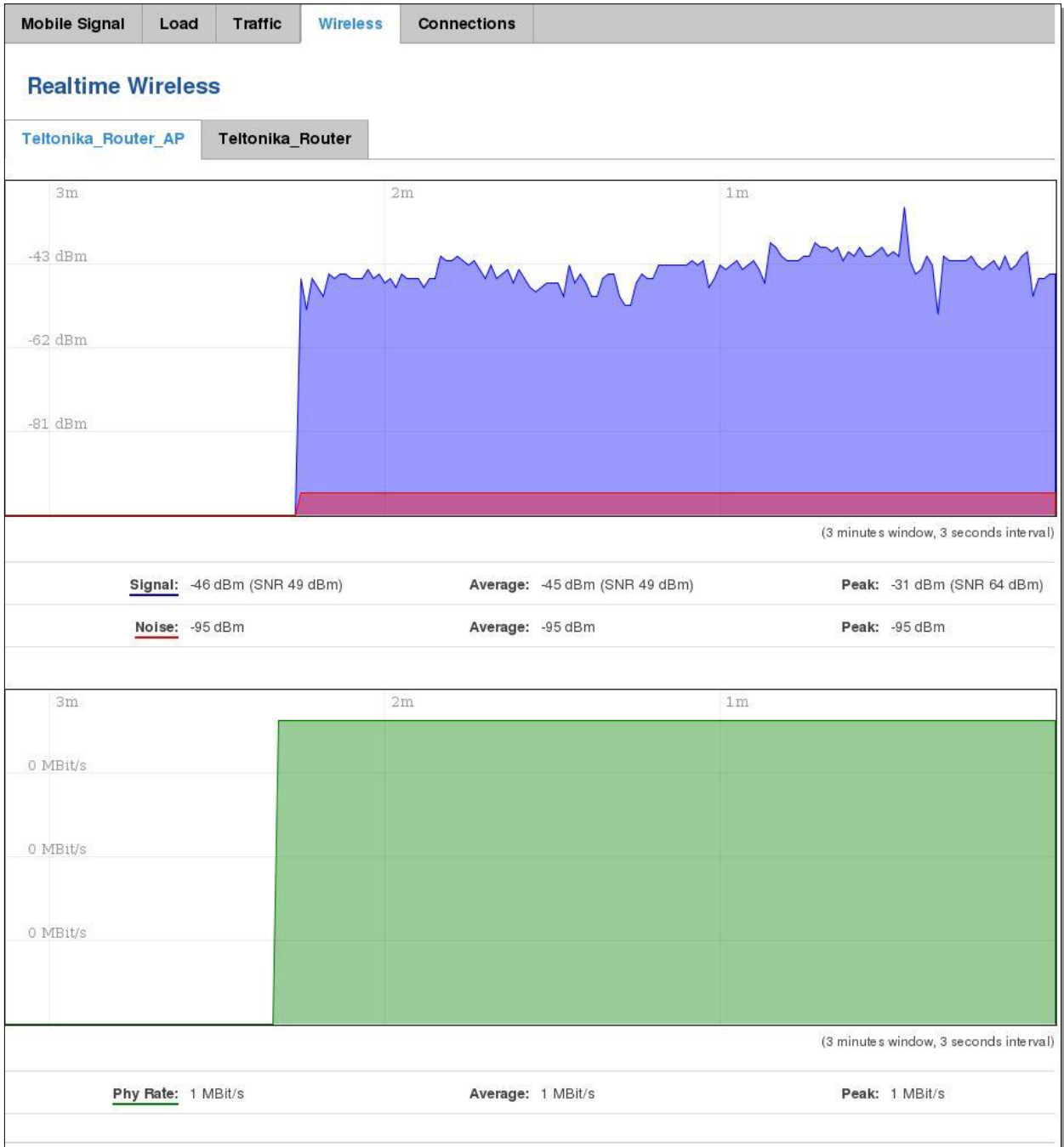

6.7.5 Realtime Connections

Displays currently active network connections with the information about network, protocol, source and destination addresses, transfer speed.

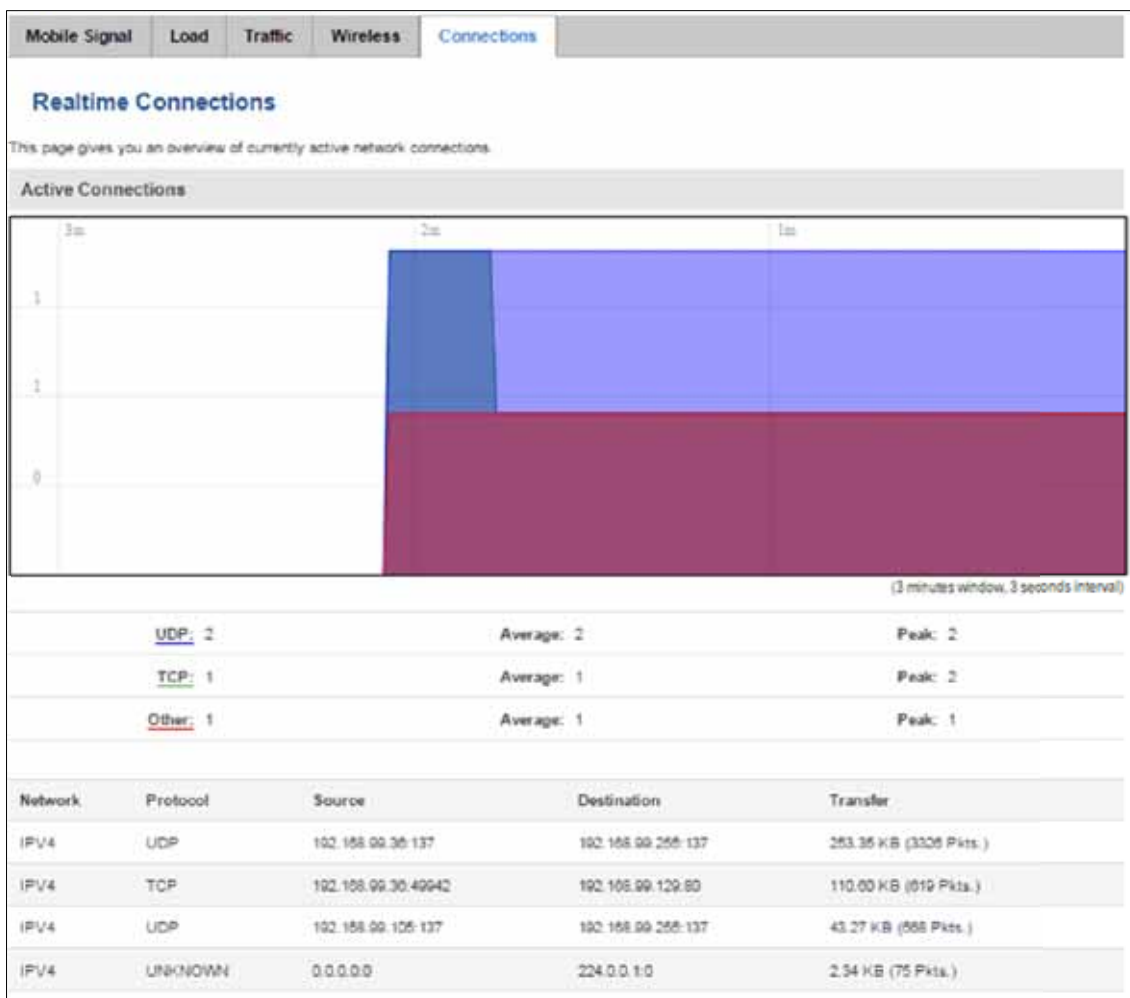

6.8 Mobile Traffic

Displays mobile connection data sent and received in KB of this day, week and month.

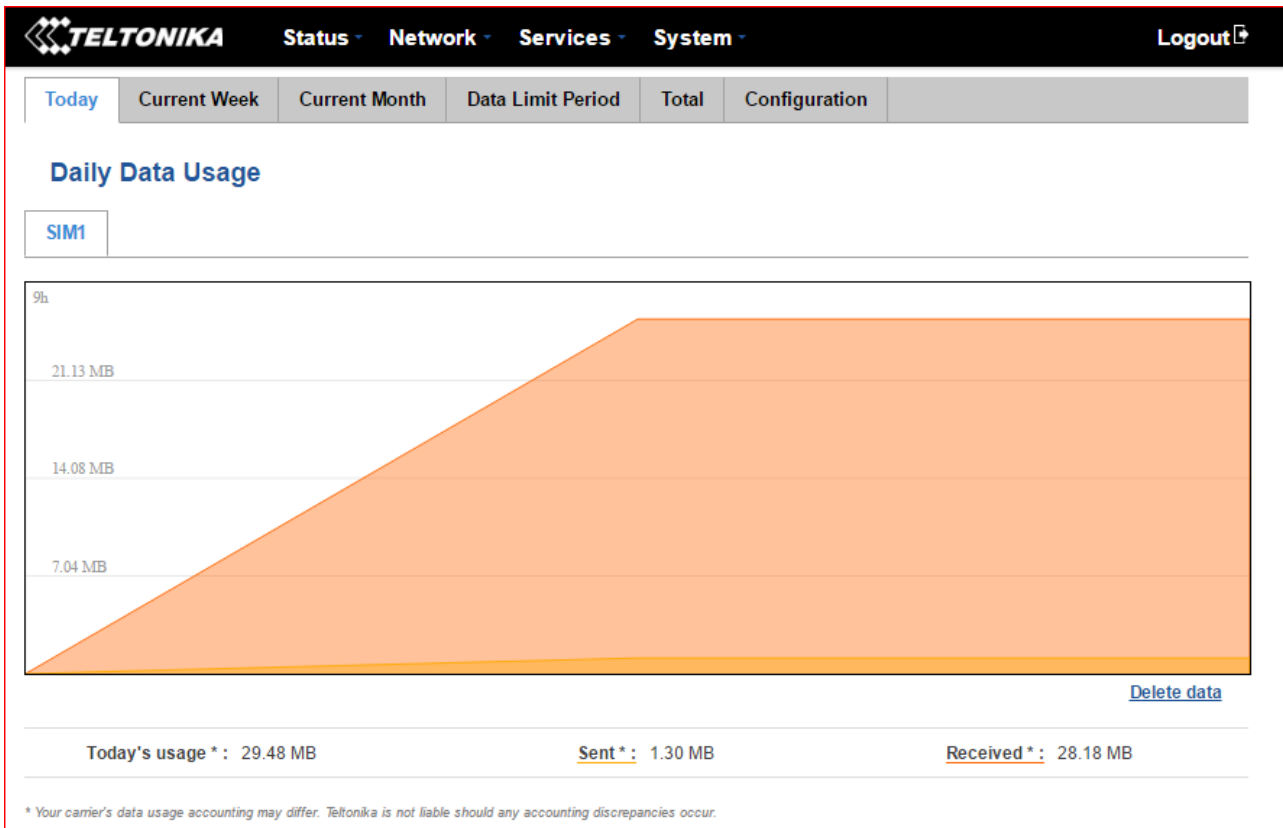

By default mobile traffic usage logging is disabled. To use this functionality is needed to enable it.

Mobile Traffic Usage Logging

Enable

Interval between records (sec)

Save

1.	Enable	Enable/Disable	Make the functionality active/inactive
2.	Interval between records (sec)	60	The interval between logging records (minimum 60 sec)

6.9 Events Log

Event log displays such actions as: login, reboot, firmware flashing and reset.

6.9.1 All Events

Displays all router events, their types and time of occurrence.

6.9.2 System Events

Displays all system events, their type and time of occurrence. Events include authentication or reboot requests, incoming and outgoing SMS and Calls, Mails, Configuration changes and DHCP events.

6.9.3 Network Events

Displays information about recent network events like connection status change, lease status change, network type or operator change.

7 Network

7.1 Mobile

7.1.1 General

7.1.1.1 Mobile configuration

Here you can configure mobile settings which are used when connecting to your local 3G network.

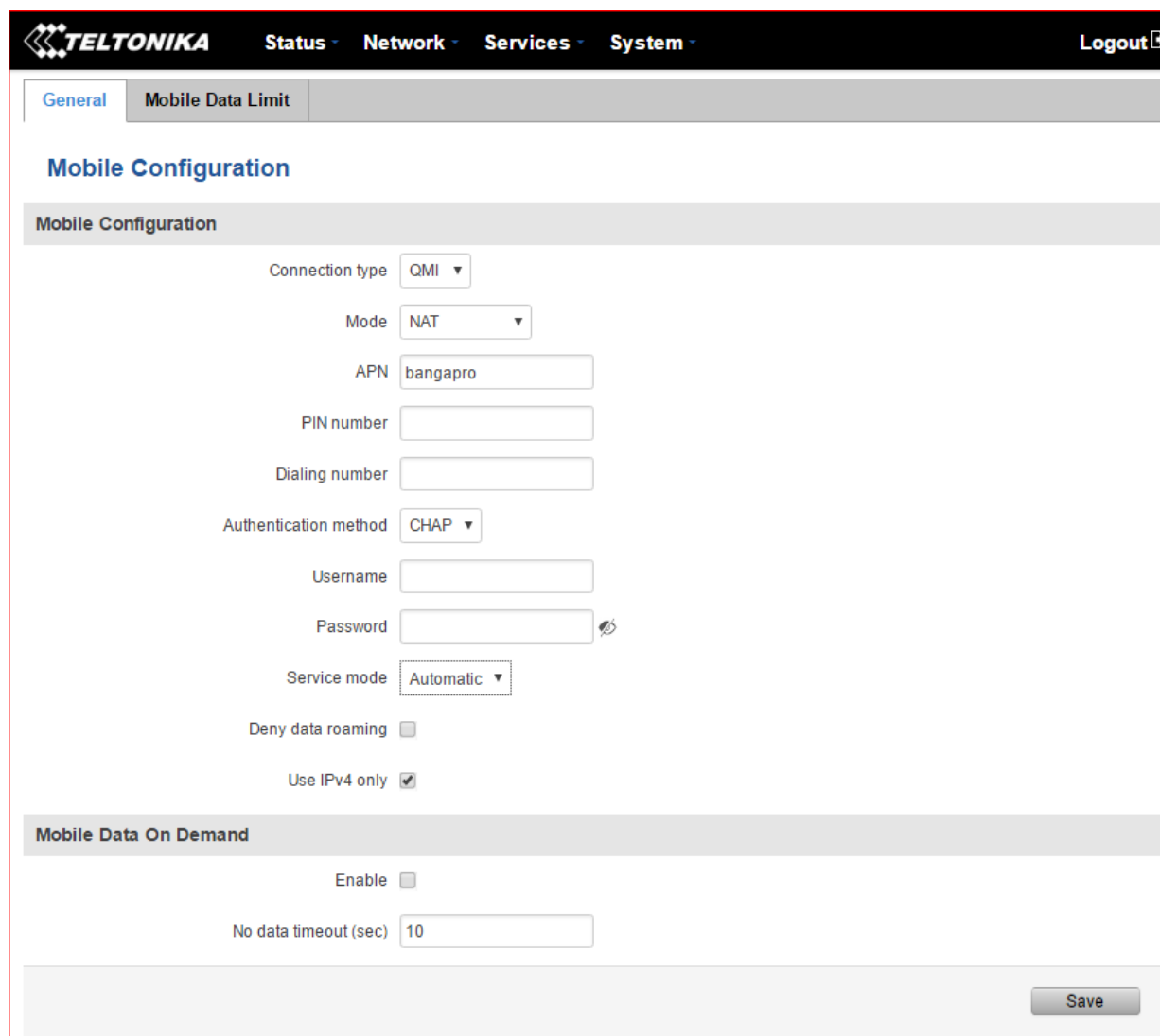

The screenshot displays the Teltonika web interface for configuring mobile settings. The top navigation bar includes the Teltonika logo and menu items: Status, Network, Services, and System. A Logout button is located in the top right corner. The main content area is titled "Mobile Configuration" and is divided into two sections: "Mobile Configuration" and "Mobile Data On Demand".

Mobile Configuration

- Connection type: QMI (dropdown)
- Mode: NAT (dropdown)
- APN: bangapro (text input)
- PIN number: (text input)
- Dialing number: (text input)
- Authentication method: CHAP (dropdown)
- Username: (text input)
- Password: (text input with eye icon for visibility toggle)
- Service mode: Automatic (dropdown)
- Deny data roaming:
- Use IPv4 only:

Mobile Data On Demand

- Enable:
- No data timeout (sec): 10 (text input)

A "Save" button is located at the bottom right of the configuration area.

1.	Connection type	QMI	The connection type used when connecting to a network. It can either be PPP or QMI. PPP is considerably slower than QMI.
2.	Mode	NAT / Passthrough	NAT mode enables network address translation on router. Passthrough mode is similar with bridge mode except that in passthrough mode router do have internet connection.
3.	APN	“bangapro”	Access Point Name (APN) is a configurable network identifier used by a mobile device when connecting to a GSM carrier.
4.	PIN number	Any number that falls between 0000 and 9999	A personal identification number is a secret numeric password shared between a user and a system that can be used to authenticate the user to the system. Use this only if your SIM card has PIN enabled.
5.	Dialing number		Dialing number is used to establish a mobile PPP (Point-to-Point-Protocol) connection.
6.	Authentication method	CHAP, PAP or none	Authentication method, which your carrier uses to authenticate new connections. (This selection is unavailable on the alternate model)
7.	Username	“username”	Your username that you would use to connect to your carrier’s network. This field becomes available when you select an authentication method (i.e. authentication method is not “none”).
8.	Password	“password”	Your password that you would use to connect to your carrier’s network. This field becomes available when you select an authentication method (i.e. authentication method is not “none”).
9.	Service mode	2G only, 3G only, or automatic.	Your network preference. If your local mobile network supports 2G and 3G you can specify to which network you wish to connect, e.g.: if you choose 2G only, the router will connect only to a 2G network. If you select auto, then the router will connect to the network that provides better connectivity.
10.	Deny data roaming	Enable/Disable	If enabled this function prevents the device from establishing mobile data connection while not in home network.
11.	Use IPv4 only	Enable / Disable	If enabled this function makes the device to use only IPv4 settings when connecting to operator.

Warning: If an invalid PIN number was entered (i.e. the entered PIN does not match the one that was used to protect the SIM card), your SIM card will get blocked. To avoid such mishaps it is highly advised to use an unprotected SIM. If you happen to insert a protected SIM and the PIN number is incorrect, your card won’t get blocked immediately, although after a couple of reboots OR configuration saves it will.

1.1.1.1.1 Passthrough mode

Mode

APN

PIN number

Dialing number

Authentication method

Service mode

Deny data roaming

Use IPv4 only

DHCP mode

MAC Address

Lease time

Using Passthrough Mode will disable most of the router capabilities!

DHCP mode: Static

Enter your computer's MAC address (xx:xx:xx:xx:xx:xx) to MAC Address field and select Lease time (expiration time for leased addresses). Device, whose MAC address will be entered, will get IP from the GSM operator. Other connected devices will get IP from the router's DHCP server, but these devices will not have internet access.

DHCP mode: Dynamic

When using Dynamic mode, the device will get an IP from the GSM operator, which connects to the router first. When using Passthrough in dynamic mode, the DHCP in LAN configuration will be disabled.

DHCP mode: No DHCP

Using no DHCP mode, the IP (also subnet, gateway and DNS) should be entered manually on your device which you are trying to connect to the router's LAN. When using Passthrough in no DHCP mode, the DHCP in LAN configuration will be disabled.

7.1.1.2 Mobile Data On Demand

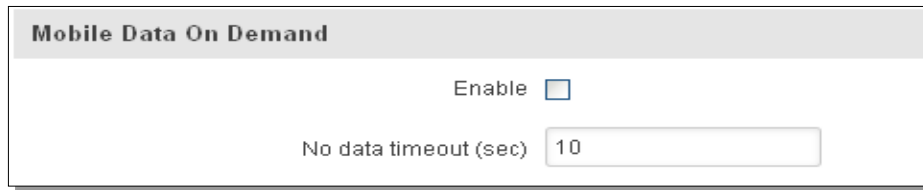

Mobile Data On Demand

Enable

No data timeout (sec)

1.	Enable	Enable/Disable	Mobile Data On Demand function enables you to keep mobile data connection on only when it's in use.
2.	No data timeout(sec)	10-99999999	The time it takes for mobile data connection to be terminated if there is no network activity.

7.1.2 Mobile Data Limit

This function lets you limit maximum amount of data transferred on WAN interface in order to minimize unwanted traffic costs.

7.1.2.1 Data Connection Limit Configuration

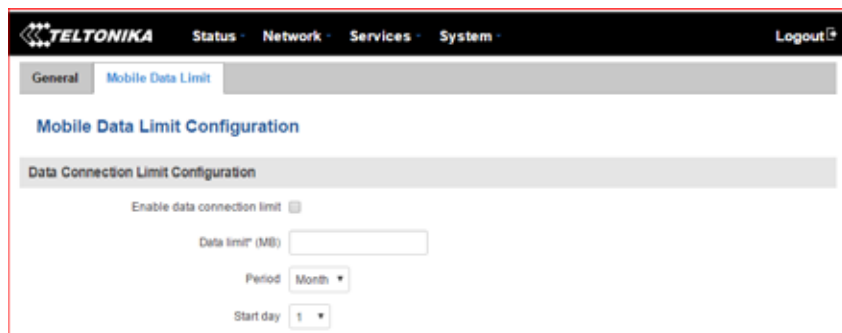

TELTONIKA Status · Network · Services · System · Logout

General **Mobile Data Limit**

Mobile Data Limit Configuration

Data Connection Limit Configuration

Enable data connection limit

Data limit (MB)

Period Month

Start day 1

* Your carrier's data usage accounting may differ. Teltonika is not liable should any accounting discrepancies occur.

usage accounting may

7.1.2.2 SMS Warning Configuration

SMS Warning Configuration

Enable SMS warning

Data limit* (MB)

Period

Start day

Phone number

* Your carrier's data usage accounting may differ. Teltonika is not liable should any accounting discrepancies occur.

7.2 WAN

7.2.1 Operation Mode

Your WAN configuration determines how the router will be connecting to the internet.

WAN

Your WAN configuration determines how the router will be connecting to the internet.

Operation Mode

Main WAN	Backup WAN		Interface Name	Protocol	IP Address	Sort
<input checked="" type="radio"/>	<input type="checkbox"/>		Mobile (WAN)	DHCP	10.132.38.224	<input type="button" value="Edit"/>
<input type="radio"/>	<input type="checkbox"/>		Wired (WAN2)	DHCP	-	↑ ↓ <input type="button" value="Edit"/>
<input type="radio"/>	<input type="checkbox"/>		WiFi (WAN3)	DHCP	-	↑ ↓ <input type="button" value="Edit"/>

1.	Main WAN	Switches between Mobile, Wired and WiFi interfaces for main WAN
2.	Backup WAN/Load balancing	Let's user select one or two interfaces for WAN backup
3.	Interface Name	Displays the WAN interface name, and changes interface priority. The interface at the table top has the highest priority
4.	Protocol	Displays the protocol used by the WAN interface
5.	IP Address	Displays IP address acquired by a specific interface
6.	Sort	Sorts table rows and changes interface priority. The highest interface has the highest priority

7.2.2 Common configuration

Common configuration allows you to configure your TCP/IP settings for the wan network.

Common Configuration

General Setup

Advanced Settings

Protocol

Really switch protocol?

You can switch between Static, DHCP or PPPoE protocol by selecting the protocol that you want to use and then pressing **Switch Protocol**.

7.2.2.1 General Setup

7.2.2.1.1 Static:

The screenshot shows the 'Common Configuration' window with the 'General Setup' tab selected. The 'Protocol' is set to 'Static'. The following fields are filled in:

- IPv4 address: 192.168.99.162
- IPv4 netmask: 255.255.255.0
- IPv4 gateway: 192.168.99.254
- IPv4 broadcast: 192.168.99.255
- Use custom DNS servers: 8.8.8.8 and 8.8.6.6

This is the configuration setup for when you select the static protocol.

1.	IPv4 address	192.168.99.162	Your router's address on the WAN network
2.	IPv4 netmask	255.255.255.0	A mask used to define how "large" the WAN network is
3.	IPv4 gateway	192.168.99.254	Address where the router will send all the outgoing traffic
4.	IPv4 broadcast	192.168.99.255	Broadcast address (auto generated if not set). It is best to leave this blank unless you know what you are doing.
5.	Use custom DNS servers	8.8.8.8 8.8.6.6	Usually the gateway has some predefined DNS servers. As such the router, when it needs to resolve a hostname ("www.google.com", "www.cnn.com", etc...) to an IP address, it will forward all the DNS requests to the gateway. By entering custom DNS servers the router will take care of host name resolution. You can enter multiple DNS servers to provide redundancy in case the one of the server fails.

7.2.2.1.2 DHCP:

The screenshot shows the 'Common Configuration' window with the 'General Setup' tab selected. The 'Protocol' is set to 'DHCP'. The following field is filled in:

- Hostname to send when requesting DHCP: Teltonika

When you select the DHCP protocol you can use it as is, because most networks will not require any additional advanced configuration.

7.2.2.1.3 PPPoE

This protocol is mainly used by DSL providers:

The screenshot shows the 'Common Configuration' window with the 'Advanced Settings' tab selected. The 'Protocol' dropdown is set to 'PPPoE'. Below it are four input fields: 'PAP/CHAP username' with the value 'test', 'PAP/CHAP password' with masked characters '••••', 'Access Concentrator' with the value 'auto', and 'Service Name' with the value 'auto'.

This is the configuration setup for when you select PPPoE protocol.

1.	PAP/CHAP username	test	Your username and password that you would use to connect to your carrier's network.
2.	PAP/CHAP password	your_password	A mask used to define how "large" the WAN network is
3.	Access Concentrator	auto	Specifies the name of the access concentrator. Leave empty to auto detect.
4.	Service Name	auto	Specifies the name of the service. Leave empty to auto detect.

7.2.2.2 Advanced

These are the advanced settings for each of the protocols, if you are unsure of how to alter these attributes it is highly recommended to leave them to a trained professional:

7.2.2.2.1 Static

The screenshot shows the 'Common Configuration' window with the 'Advanced Settings' tab selected. It features a 'Disable NAT' checkbox which is checked. Below it are four input fields: 'Override MAC address' with the value '88:48:71:B7:E9:E4', 'Override MTU' with the value '1500', and 'Use gateway metric' with the value '0'.

1.	Disable NAT	On/Off	Toggle NAT on and off.
2.	Override MAC address	86:48:71:B7:E9:E4	Override MAC address of the WAN interface. If your ISP gives you a static IP address it might also bind it to your computer's MAC address (i.e. that IP will only work with your computer). In this field you can enter your computer's MAC address and "fool" the gateway in thinking that it is communicating with your computer.
3.	Override MTU	1500	Maximum Transmission Unit – specifies the largest possible size of a data packet.
4.	Use gateway metric	0	The WAN configuration by default generates a routing table entry. With this field you can alter the metric of that entry.

7.2.2.2.2 DHCP

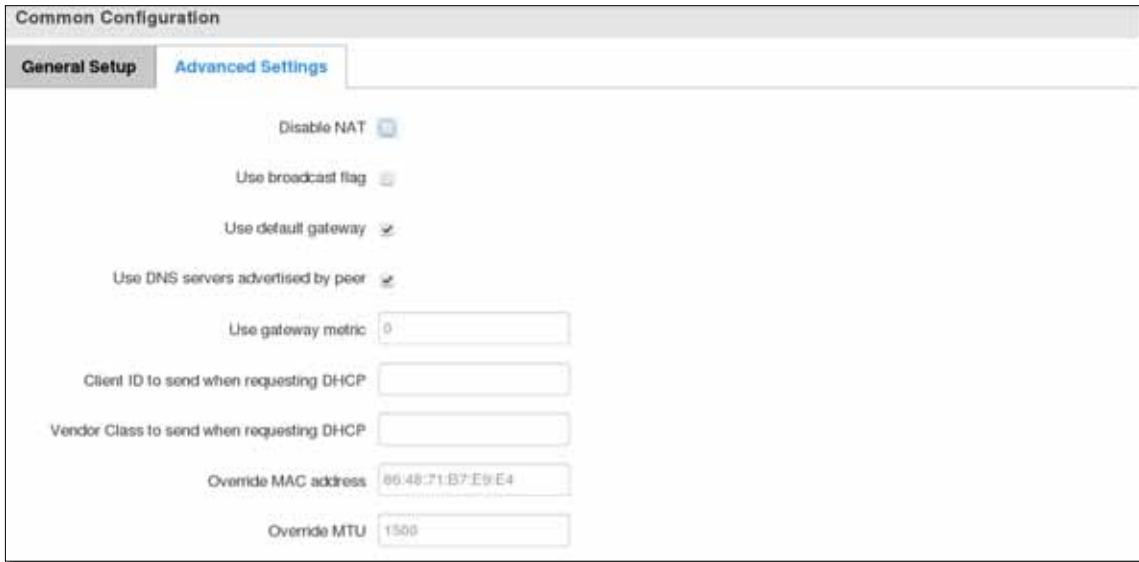

The screenshot shows the 'Advanced Settings' tab in the 'Common Configuration' section. The following settings are visible:

- Disable NAT:
- Use broadcast flag:
- Use default gateway:
- Use DNS servers advertised by peer:
- Use gateway metric:
- Client ID to send when requesting DHCP:
- Vendor Class to send when requesting DHCP:
- Override MAC address:
- Override MTU:

1.	Disable NAT	Enable/Disable	If checked, router will not perform NAT (masquerade) on this interface
2.	Use broadcast flag	Enable/Disable	Required for certain ISPs, e.g. Charter with DOCSIS 3
3.	Use default gateway	Enable/Disable	If unchecked, no default route is configured
4.	Use DNS server advertised by peer	Enable/Disable	If unchecked, the advertised DNS server addresses are ignored
5.	User gateway metric	0	The WAN configuration by default generates a routing table entry. With this field you can alter the metric of that entry.
6.	Client ID to send when requesting DHCP		Specify client ID which will be sent when requesting DHCP (Dynamic Host Configuration Protocol)
7.	Vendor Class to send when requesting DHCP		Specify the vendor class which will be sent when requesting DHCP (Dynamic Host Configuration Protocol)
8.	Override MAC address	86:48:71:B7:E9:E4	Override MAC address of the WAN interface. If your ISP gives you a static IP address it might also bind it to your computer's MAC address (i.e. that IP will only work with your computer). In this field you can enter your computer's MAC address and "fool" the gateway in thinking that it is communicating with your computer.

9.	Override MTU	1500	Maximum transmission unit – specifies the largest possible size of a data packet.
----	--------------	------	-----------------------------------------------------------------------------------

7.2.2.2.3 PPPoE

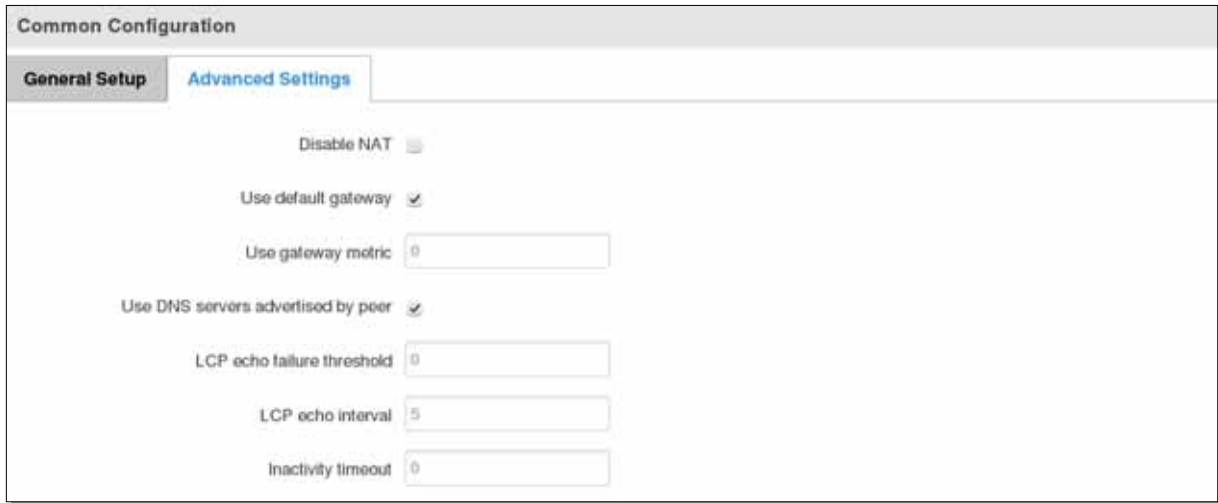

The screenshot shows the 'Common Configuration' window with the 'Advanced Settings' tab selected. The settings are as follows:

- Disable NAT:
- Use default gateway:
- Use gateway metric:
- Use DNS servers advertised by peer:
- LCP echo failure threshold:
- LCP echo interval:
- Inactivity timeout:

1.	Disable NAT	Enable/Disable	If checked, the router will not perform NAT (masquerade) on this interface
2.	Use default gateway	Enable/Disable	If unchecked, no default route is configured
3.	Use gateway metric	0	The WAN configuration by default generates a routing table entry. With this field you can alter the metric of that entry
4.	Use DNS servers advertised by peer	Enable/Disable	If unchecked, the advertised DNS server addresses are ignored
5.	LCP echo failure threshold	0	Presume peer to be dead after given amount of LCP echo failures, use 0 to ignore failures
6.	LCP echo interval	5	Send LCP echo requests at the given interval in seconds, only effective in conjunction with failure threshold
7.	Inactivity timeout	0	Close inactive connection after the given amount of seconds, use 0 to persist connection

7.2.2.2.4 IP Aliases

IP aliases are a way of defining or reaching a subnet that works in the same space as the regular network.

The screenshot shows the 'Advanced Settings' tab for IP Aliases. It contains three input fields: 'IP Address' with the value '192.168.99.161', 'Netmask' with a dropdown menu showing '255.255.255.0', and 'Gateway' with the value '192.168.99.254'. On the left side, there are 'Delete' and 'Add' buttons. At the bottom right, there is a 'Save' button.

As you can see, the configuration is very similar to the static protocol; only in the example a 99th subnet is defined. Now if some device has an IP in the 99 subnet (192.168.99.xxx) and the subnet's gateway metric is "higher" and the device is trying to reach the internet it will reroute it's traffic not to the gateway that is defined in common configurations but through the one that is specified in IP aliases.

The screenshot shows the 'Advanced Settings' tab for IP Aliases. It contains two input fields: 'IP Broadcast' and 'DNS Server'. On the left side, there are 'Delete' and 'Add' buttons. At the bottom right, there is a 'Save' button.

You may also optionally define a broadcast address and a custom DNS server.

7.2.2.2.5 Backup WAN configuration

Backup WAN is a function that allows you to back up your primary connection in case it goes down. There can be two backup connections selected at the same time, in that case, when the primary connection fails, the router tries to use the backup with higher priority and if that is unavailable or fails too, then router tries the backup with the lower priority.

The screenshot shows the 'Backup Configuration' page. It includes a title bar and a descriptive text: 'Timing and other parameters will indicate how and when it will be determined that your conventional connection has gone down.' Below this are five settings, each with a dropdown menu: 'Health monitor interval' set to '10 sec.', 'Health monitor ICMP host(s)' set to '8.8.4.4', 'Health monitor ICMP timeout' set to '3 sec.', 'Attempts before failover' set to '3', and 'Attempts before recovery' set to '3'.

The majority of the options consist of timing and other important parameters that help determine the health of your primary connection. Regular health checks are constantly performed in the form of ICMP packets (Pings) on your primary connection. When the connection's state starts to change (READY->NOT READY and vice versa) a necessary amount of failed or passed health checks has to be reached before the state changes completely. This delay is instituted so as to mitigate "spikes" in connection availability, but it also extends the time before the backup link can be brought up or down.

1.	Health monitor Interval	Disable/5/10/20/30/60/120 Seconds	The interval at which health checks are performed
2.	Health monitor ICMP host(s)	Disable/DNS Server(s) /WAN GW/Custom	Indicate where to Ping for a health check. As there is no definitive way to determine when the connection to internet is down for good, you'll have to define a host whose availability is that of the internet as a whole.
3.	Health monitor ICMP timeout	1/3/4/5/10 Seconds	How long to wait for an ICMP request to come back. Set a higher value if your connection has high latency or high jitter (latency spikes).
4.	Attempts before failover	1/3/5/10/15/20	How many failed checks before your WAN connection is declared DOWN for good.
5.	Attempts before recovery	1/3/5/10/15/20	How many checks before your WAN connection is declared UP.

7.2.2.3 How do I set up a backup link?

First we must select a main link and choose one or two backup links in WAN section. Then push the "Edit" button and configure your WAN and Backup Wan settings to your liking. Click Save and wait until the settings are applied. Now in the Status -> Network Information -> WAN page there should be a status indication for the backup WAN. If everything is working correctly you should see something like this:



The above picture shows the status for Backup WAN configured on a wired main link. You can now simulate a downed link by simply unplugging your Ethernet WAN cable. When you've done so you should see this:



And, if you plug the cable back in you should, again, see this:



7.3 LAN

This page is used to configure the LAN network, where all your devices and computers that you connect to the router will reside.

7.3.1 Configuration

7.3.1.1 General Setup

The screenshot shows the 'Configuration' page with the 'General Setup' tab selected. The 'Advanced Settings' tab is also visible. The configuration fields are as follows:

Field	Value
IP address	192.168.1.1
IP netmask	255.255.255.0
IP broadcast	

1.	IP address	192.168.1.1	Address that the router uses on the LAN network
2.	IP netmask	255.255.255.0	A mask used to define how “large” the LAN network is
3.	IP broadcast		IP broadcasts are used by BOOTP and DHCP clients to find and send requests to their respective servers

3.1.1.1

7.3.1.2 Advanced settings

The screenshot shows the 'Configuration' page with the 'Advanced Settings' tab selected. The configuration options are as follows:

Option	Value
Accept router advertisements	<input type="checkbox"/>
Override MTU	1500
Use gateway metric	0
Use WAN port as LAN	<input type="checkbox"/>

1.	Accept router advertisements	Enable/Disable	If enabled allows accepting router advertisements (Disabled by default).
2.	Override MTU	1500	MTU (Maximum Transmission Unit) specifies the largest possible size of a data packet.
3.	Use gateway metric	0	The LAN configuration by default generates a routing table entry. With this field you can alter the metric of that entry.
4.	Use WAN port as LAN	Enable/Disable	When enabled it allows you to use the WAN port as a LAN port.

7.3.2 DHCP Server

The DHCP server is the router's side service that can automatically configure the TCP/IP settings of any device that requests such a service. If you connect a device that has been configured to obtain IP address automatically the DHCP server will lease an IP address and the device will be able to fully communicate with the router.

7.3.2.1 General Setup

DHCP Server

General Setup

Advanced Settings

DHCP

Start

Limit

Lease time

1.	DHCP	Enable / Disable/ DHCP Relay	Manage DHCP server
2.	Start	100	The starting address of the range that the DHCP server can use to give out to devices. E.g.: if your LAN IP is 192.168.2.1 and your subnet mask is 255.255.255.0 that means that in your network a valid IP address has to be in the range of [192.168.2.1 – 192.168.2.254](192.168.2.0 and 192.168.2.255 are special unavailable addresses). If the Start value is set to 100 then the DHCP server will only be able to lease out addresses starting from 192.168.2.100
3.	Limit	150	How many addresses the DHCP server gets to lease out. Continuing on the above example: if the start address is 192.168.2.100 then the end address will be 192.168.2.254 (100 + 155 – 1 = 254).
4.	Lease time	12	How long a leased IP will be considered valid. An IP address after the specified amount of time will expire and the device that leased it out will have to request a new one. Select Hours or Minutes (minimum 2min).

7.3.2.2 Advanced settings

You can also define some advanced options that specify how the DHCP server will operate on your LAN network.

The screenshot shows the 'Advanced Settings' tab for the DHCP Server configuration. It includes the following elements:

- Dynamic DHCP:** A checked checkbox.
- Force:** An unchecked checkbox.
- IP netmask:** An empty text input field.
- DHCP Options:** An empty text input field with a green plus icon to its right.

1.	Dynamic DHCP	Checked/Unchecked	Dynamically allocate client addresses, if set to 0 only clients present in the <code>ethers</code> files are served
2.	Force	Checked/Unchecked	Forces DHCP serving even if another DHCP server is detected on the same network segment.
3.	IP netmask		You can override your LAN netmask here to make the DHCP server think it's serving a larger or a smaller network than it actually is.
4.	DHCP Options		Additional options to be added for this DHCP server. For example with '26,1470' or 'option:mtu, 1470' you can assign an MTU per DHCP. Your client must accept MTU by DHCP for this to work.

7.3.2.3 Static Leases

This page is used to configure static IP leases.

The screenshot shows the 'Static Leases' configuration page. It features a table with the following structure:

Hostname	MAC address	IP address	
Printer	10:a5:d0:70:9c:72 (192.168.1.104)	192.168.1.104	Delete

Below the table is an 'Add' button.

1.	Hostname	Printer	The name which will be linked with IP address.
2.	MAC address	10:a5:d0:70:9c:72 (192.168.1.104)	Device's MAC address
3.	IP address	192.168.1.104	Device's IP address

7.3.2.4 IP Aliases

7.3.2.4.1 General Setup

IP aliases are the way of defining or reaching a subnet that works in the same space as the regular network.

IP Aliases

General Setup **Advanced Settings**

IP Address

Netmask

Gateway

7.3.2.4.2 Advanced Settings

You may also optionally define a broadcast address and a custom DNS server.

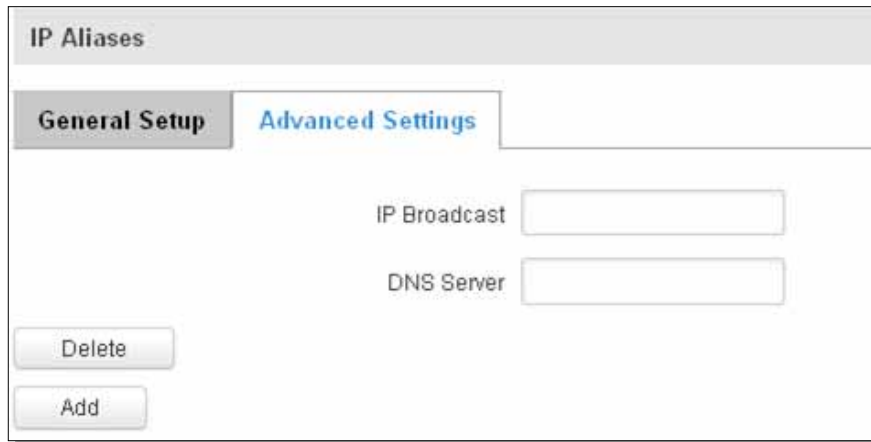

The screenshot shows a configuration window titled "IP Aliases". It has two tabs: "General Setup" and "Advanced Settings". The "Advanced Settings" tab is active. Inside this tab, there are two input fields: "IP Broadcast" and "DNS Server". Below these fields are two buttons: "Delete" and "Add".

IP Aliases	
General Setup	Advanced Settings
IP Broadcast	<input type="text"/>
DNS Server	<input type="text"/>
<input type="button" value="Delete"/>	
<input type="button" value="Add"/>	

7.4 Wireless

On this page you can configure your wireless settings. Depending on whether your WAN mode is set to WiFi or not, the page will display either the options for configuring an **Access Point** or options for configuring a **connection** to a local access point.

Access Point:

Wireless Access Point

Here you can configure your wireless settings like radio frequency, mode, encryption etc...

Device Configuration

General Setup **Advanced Settings**

Enable wireless

Channel

Interface Configuration

General Setup **Wireless Security** **MAC Filter** **Advanced Settings**

SSID

Hide SSID

WRP100 Configuration

Connect WRP100 automatically

Here you can see the Overview of the wireless configuration. It is divided into two main sections – device and interface. One is dedicated to configuring hardware parameters, the other – software.

Here you can toggle the availability of the wireless radio and the physical channel frequency.

Important note: As seen in the picture you should always **Save** before toggling the radio on and off.

SSID – Your wireless network’s identification string. This is the name of your WiFi network. When other WiFi capable computers or devices scan the area for WiFi networks they will see your network with this name.

Hide SSID – Will render your SSID hidden from other devices that try to scan the area.

Connect to WRP100 automatically – let Teltonika WRP100 wireless repeater connect to this router automatically.

7.4.1.1 Device

7.4.1.1.1 Advanced Settings

General Setup | **Advanced Settings**

Mode: 802.11g+n ▼

Country code: 00 - World ▼

Transmit power: 100 % ▼

Fragmentation threshold: 2346

RTS/CTS threshold: 2346

Here you can configure more advanced parameters:

1.	Mode	Auto, b, g, g+n	Different modes provide different throughput and security options.
2.	Country Code	Any ISO/IEC 3166 alpha2 country code	Selecting this will help the wireless radio configure it's internal parameters to meet your country's wireless regulations.
3.	Transmit power	20%/40%/60%/80%/100%	Select WiFi signal power
4.	Fragmentation threshold	2346	The smallest packet size that can be fragmented and transmitted by multiple frames. In areas where interference is a problem, setting a lower fragment threshold might help reduce the probability of unsuccessful packet transfers, thus increasing speed.
5.	RTS/CTS Threshold	2346	Request to send threshold. It can help resolve problems that arise when several access points are in the same area, contending.

7.4.1.2 Interface

7.4.1.2.1 Security

Encryption – there are many modes of encryption, a distinctive class is pointed out below.

Interface Configuration

General Setup | **Wireless Security** | MAC Filter | Advanced Settings

Encryption: WPA-PSK/WPA2-PSK mixed mode ▼

Cipher: Auto ▼

Key: 🔒

First select an encryption method: TKIP, CCMP, TKIP&CCMP and auto. Note: Some authentication methods won't support TKIP (and TKIP&CCMP) encryption. After you've selected your encryption method, you should enter your pass phrase, which must be at least 8 characters long.

7.4.1.2.2 MAC-Filter

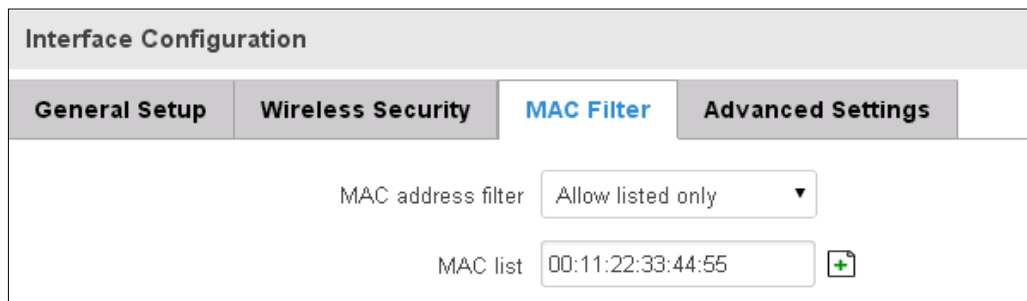

Filter – you can define a rule for what to do with the MAC list you've defined. You can either allow only the listed MACs or allow ALL, but forbid the listed ones.

7.4.1.2.3 Advanced settings

Separate clients – prevents WiFi clients from communicating with each other on the same subnet.

Increase TTL packet size – increase TTL packet size for incoming packets.

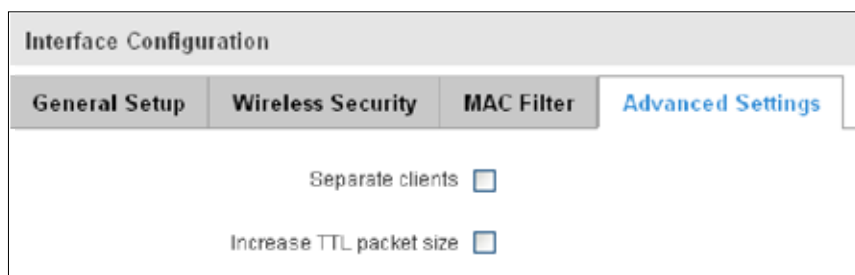

7.4.1.3 Client

RUT230 can work as a WiFi client. Client mode is nearly identical to AP, except for the fact that most of the options are dictated by the wireless access point that the router is connecting to. Changing them can result in an interrupted connection to an AP.

In addition to standard options you can also click the **Scan** button to re-scan the surrounding area to attempt to connect to a new wireless access point.

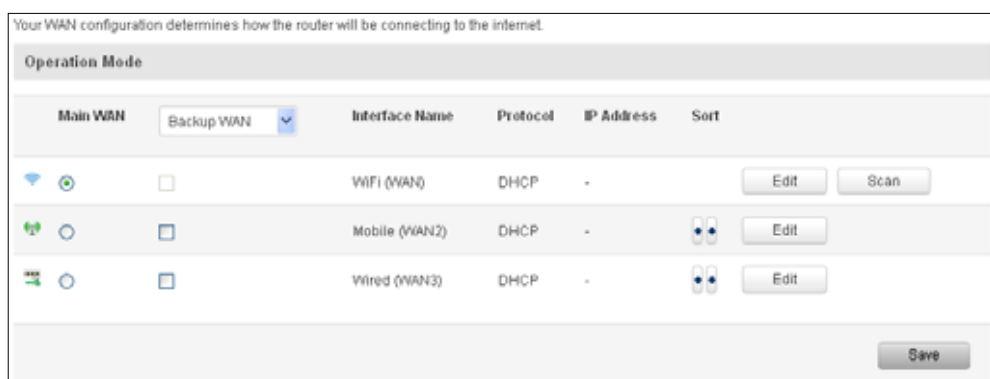

7.5 VLAN

On this page you can configure your Virtual LAN settings.

7.5.1 VLAN Networks

7.5.1.1 VLAN Functionality

VLAN Functionality

VLAN mode: Disabled

1.	VLAN mode	Disabled / Tag based	Lets the user choose the VLAN mode or disable VLAN functionality.
----	-----------	----------------------	-------------------------------------------------------------------

7.5.1.2 VLAN mode – Tag based:

VLAN Networks List

VLAN ID	Wireless access points	LAN
2	Teltonika_Router <input type="checkbox"/>	None <input type="button" value="Delete"/>

1.	VLAN ID	2	VLAN Identification number, allowed in range (1-4094)
3.	Wireless access points	Enabled / Disabled	Assign selected access point(s) to selected LAN.
4.	LAN	None	Select to which LAN the wireless access point(s) will be applied.

7.5.2 LAN Networks

In this page you can create extra LAN networks, and assign them with LAN Ports and wireless access points. You can get extra information on how to configure any of your LAN's settings in section – 7.3 LAN

LAN

LAN Networks List

LAN name	Interface name
Lan	eth0 tap0 <input type="button" value="Edit"/>

LAN name: LAN2

1.	LAN name	Lan	Specifies new LAN name
----	----------	-----	------------------------

2.	Interface name	eth0 tap0	Specifies LAN interface name
----	----------------	-----------	------------------------------

7.6 Firewall

In this section we will look over the various firewall features that come with RUT230.

7.6.1 General Settings

The router's firewall is a standard Linux iptables package, which uses routing chains and policies to facilitate control over inbound and outbound traffic.

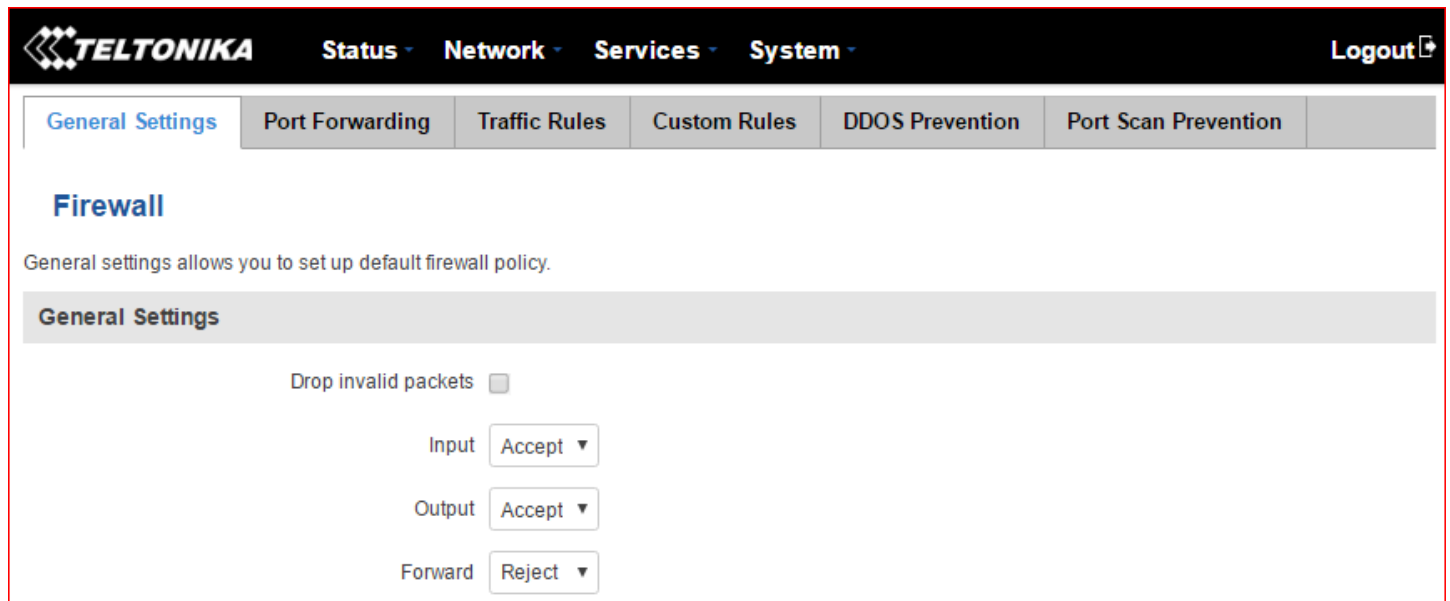

The screenshot shows the Teltonika web interface. At the top, there is a navigation bar with 'TELTONIKA' logo and menu items: 'Status', 'Network', 'Services', and 'System'. A 'Logout' button is in the top right. Below the navigation bar, there is a sub-menu with 'General Settings' (selected), 'Port Forwarding', 'Traffic Rules', 'Custom Rules', 'DDOS Prevention', and 'Port Scan Prevention'. The main content area is titled 'Firewall' and contains the text: 'General settings allows you to set up default firewall policy.' Below this, there is a 'General Settings' section with the following options:

- Drop invalid packets:
- Input: Accept (dropdown)
- Output: Accept (dropdown)
- Forward: Reject (dropdown)

1.	Drop Invalid packets	Checked/Unchecked	A "Drop" action is performed on a packet that is determined to be invalid
2.	Input	Reject/Drop/Accept	DEFAULT* action that is to be performed for packets that pass through the Input chain.
3.	Output	Reject/Drop/Accept	DEFAULT* action that is to be performed for packets that pass through the Output chain.
4.	Forward	Reject/Drop/Accept	DEFAULT* action that is to be performed for packets that pass through the Forward chain.

*DEFAULT: When a packet goes through a firewall chain it is matched against all the rules for that specific chain. If no rule matches said packet, an according Action (either Drop or Reject or Accept) is performed.

Accept – Packet gets to continue down the next chain.

Drop – Packet is stopped and deleted.

Reject – Packet is stopped, deleted and, differently from Drop, an ICMP packet containing a message of rejection is sent to the **source** of the dropped packet.

7.6.2 DMZ

DMZ Configuration

Enable

DMZ host IP address

By enabling DMZ for a specific internal host (e.g.: your computer), you will expose that host and its services to the router's WAN network (i.e. - internet).

7.6.3 Port Forwarding

Here you can define your own port forwarding rules.

Firewall - Port Forwarding

Port forwarding allows remote computers on the Internet to connect to a specific computer or service within the private LAN.

Port Forwarding Rules

Name	Protocol	Source	Via	Destination	Enable	Sort	
Enable_SSH_WAN_PASSTHROUGH	TCP	From any host in wan	To any router IP at port 22	Forward to IP 127.0.0.1, port 22 in lan	<input type="checkbox"/>	↕	Edit Delete
Enable_HTTP_WAN_PASSTHROUGH	TCP	From any host in wan	To any router IP at port 80	Forward to IP 127.0.0.1, port 80 in lan	<input type="checkbox"/>	↕	Edit Delete
Enable_HTTPS_WAN_PASSTHROUGH	TCP	From any host in wan	To any router IP at port 443	Forward to IP 127.0.0.1, port 443 in lan	<input type="checkbox"/>	↕	Edit Delete
Enable_CLI_WAN_PASSTHROUGH	TCP	From any host in wan	To any router IP at port 4200	Forward to IP 127.0.0.1, port 4200 in lan	<input type="checkbox"/>	↕	Edit Delete

New Port Forward Rule

Name	Protocol	External port (s)	Internal IP	Internal port (s)	
<input type="text" value="Enable_Test_Rule"/>	TCP+UDP	<input type="text" value="12345"/>	<input type="text" value="192.168.1.109"/>	<input type="text" value="12345"/>	Add

You can use port forwarding to set up servers and services on local LAN machines. The above picture shows how you can set up a rule that would allow a website that is being hosted on 192.168.1.109, to be reached from the outside by entering `http://routersExternalIp:12345/`.

1.	Name	Enable_SSH_WAN_PASSTHROUGH	Name of the rule. Used purely to make it easier to manage rules.
2.	Protocol	TCP/UDP/TCP+UDP/Other	The type of protocol of the incoming packet.
3.	External Port	1-65535	The traffic will be forwarded from this port of the WAN network.
4.	Internal IP address	IP address of a computer on your LAN	The IP address of the internal machine that hosts a service that we want to access from the outside.
5.	Internal port	1-65535	The rule will redirect the traffic to that port of the internal machine.

When you click **edit** you can fine tune a rule to near perfection, if you should desire that.

This page allows you to change advanced properties of the port forwarding entry. Although, in most cases there is no need to modify those settings.

Enable
 Name:
 Protocol:
 Source zone: lan: lan: vpn: openvpn: gre tunnel: wan: wan: ppp:
 Source MAC address:
 Source IP address:
 Source port:
 External IP address:
 External port:
 Internal zone: lan: lan: vpn: openvpn: gre tunnel: wan: wan: ppp:
 Internal IP address:
 Internal port:
 Enable NAT loopback
 Extra arguments:

1.	Name	ENABLE_SSH_WAN_PASSTHROUGH	Name of the rule. Used purely to make it easier to manage rules.
2.	Protocol	TCP/UDP/TCP+ UDP/ICMP/Custom	You may specify multiple by selecting (custom) and then entering protocols separated by space
3.	Source zone	LAN/VPN/WAN	Match incoming traffic from this zone only
4.	Source MAC address	any	Match incoming traffic from these MACs only
5.	Source IP address	any	Match incoming traffic from this IP or range only
7.	Source port	any	Match incoming traffic originating from the given source port or port range on the client host only

8.	External IP address	any	Match incoming traffic directed at the given IP address only
9.	External port	22	Match incoming traffic directed at the given destination port or port range on this host only
10.	Internal zone	LAN/VPN/WAN	Redirect matched incoming traffic to the specified internal zone
11.	Internal IP address	127.0.0.1	Redirect matched incoming traffic to the specified internal host
12.	Internal port	any	Redirect matched incoming traffic to the given port on the internal host
13.	Enable NAT loopback	Enable/Disable	NAT loopback enables your local network (i.e. behind your router/modem) to connect to a forward-facing IP address (such as 208.112.93.73) of a machine that it also on your local network
14.	Extra arguments		Passes additional arguments to iptables. Use with care!

7.6.4 Traffic Rules

The traffic rule page contains a more generalized rule definition. With it you can block or open ports, alter how traffic is forwarded between LAN and WAN and many more things.



Status ▾
Network ▾
Services ▾
System ▾

Logout ↗

General Settings
Port Forwarding
Traffic Rules
Custom Rules
DDOS Prevention
Port Scan Prevention

Firewall - Traffic Rules

Traffic rules define policies for packets traveling between different zones, for example to reject traffic between certain hosts or to open WAN ports on the router.

Name	Protocol	Source	Destination	Action	Enable	Sort	
Allow-DHCP-Relay	UDP	From any host in wan	To any router IP at port 67 on this device	Accept input	<input type="checkbox"/>	↕ ↕	<div style="display: flex; gap: 5px;"> Edit Delete </div>
Allow-DHCP-Renew	UDP	From any host in wan	To any router IP at port 68 on this device	Accept input	<input checked="" type="checkbox"/>	↕ ↕	<div style="display: flex; gap: 5px;"> Edit Delete </div>
Allow-Ping	ICMP with type echo-request	From any host in wan	To any router IP on this device	Accept input	<input checked="" type="checkbox"/>	↕ ↕	<div style="display: flex; gap: 5px;"> Edit Delete </div>
Allow-vpn-traffic	TCP, UDP	From any host in wan	To any router IP at port 1194 on this device	Accept input	<input checked="" type="checkbox"/>	↕ ↕	<div style="display: flex; gap: 5px;"> Edit Delete </div>

1.	Name	Name of the rule. Used for easier rules management purpose only
2.	Protocol	Protocol type of incoming or outgoing packet
3.	Source	Match incoming traffic from this IP or range only
4.	Destination	Redirect matched traffic to the given IP address and destination port
5.	Action	Action to be taken for the packet if it matches the rule
6.	Enable	Self-explanatory. Uncheck to make the rule inactive. The rule will not be deleted, but it also will not be loaded into the firewall.
7.	Sort	When a packet arrives, it gets checked for a matching rule. If there are several rules that match the rule, the first one is applied i.e. the order of the rule list impacts how your firewall operates, therefore you are given the ability to sort your list as you wish.

You can configure firewall rule by clicking **edit** button.

This page allows you to change advanced properties of the traffic rule entry, such as matched source and destination hosts.

Enable

Name

Restrict to address family

Protocol

Match ICMP type

Source zone Any zone
 lan: lan:

vpn: openvpn: gre tunnel:

wan: wan: ppp:

Source MAC address

Source address

Source port

Destination zone Device (input)
 Any zone (forward)
 lan: lan:

vpn: openvpn: gre tunnel:

wan: wan: ppp:

Destination address

Destination port

Action

Extra arguments

1.	Name	"Allow-DHCP-Relay"	Used to make rule management easier
2.	Restrict to address family	IPv4 and IPV6	Match traffic from selected address family only
3.	Protocol	TCP/UDP/Any/ICMP/Custom	Protocol of the packet that is being matched against traffic rules.
4.	Match ICMP type	any	Match traffic with selected ICMP type only

5.	Source zone	any zone/LAN/VPN/WAN	Match incoming traffic from this zone only
6.	Source MAC address	any	Match incoming traffic from these MACs only
7.	Source address	any	Match incoming traffic from this IP or range only
8.	Source port	any	Match incoming traffic originating from the given source port or port range on the client host only
9.	Destination zone	Device/Any zone/LAN/VPN/WAN	Match forwarded traffic to the given destination zone only
10.	Destination address	any	Match forwarded traffic to the given destination IP address or IP range only
11.	Destination port	67	Match forwarded traffic to the given destination port or port range only
12.	Action	Drop/Accept/Reject + chain + additional rules	Action to be taken on the packet if it matches the rule. You can also define additional options like limiting packet volume, and defining to which chain the rule belongs

7.6.4.1 Open Ports On the Router

Open Ports On Router

Name	Protocol	External port	
<input type="text" value="Open_Port_rule"/>	TCP ▼	<input type="text" value="22"/>	<input type="button" value="Add"/>

1.	Name	Open_Port_rule	Used to make rule management easier
2.	Protocol	TCP/UDP/Any/ICMP/Custom	Protocol of the packet that is being matched against traffic rules.
3.	External port	1-65535	Match incoming traffic directed at the given destination port or port range on this host.

7.6.4.2 New Forward Rule

New Forward Rule

Name	Source	Destination	
<input type="text" value="Forward rule new"/>	LAN ▼	WAN ▼	<input type="button" value="Add"/>

1.	Name	Forward rule new	Used to make rule management easier
2.	Source	LAN/VPN/WAN	Match incoming traffic from selected address family only
3.	Protocol	TCP/UDP/Any/ICMP/Custom	Protocol of the packet that is being matched against traffic rules.

7.6.4.3 Source NAT

Source NAT is a specific form of masquerading which allows fine grained control over the source IP used for outgoing traffic, for example to map multiple WAN addresses to internal subnets.

Source NAT

Source NAT is a specific form of masquerading which allows fine grained control over the source IP used for outgoing traffic, for example to map multiple WAN addresses to internal subnets.

Name	Protocol	Source	Destination	SNAT	Enable	
SNAT	TCP+UDP	From any host in lan	To any host, port 22 in wan	Rewrite to source IP 10.101.1.10, port 22	<input checked="" type="checkbox"/>	<input type="button" value="Edit"/> <input type="button" value="Delete"/>

New Source NAT

Name	Source	Destination	Source IP	Source port
<input type="text" value="New SNAT rule"/>	<input type="button" value="LAN"/> ▾	<input type="button" value="WAN"/> ▾	<input type="text"/>	<input type="button" value="Do not rewrite"/> <input type="button" value="Add"/>

1.	Name	SNAT	Used to make rule management easier
2.	Protocol	TCP/UDP/Any/ICMP/Custom	Protocol of the packet that is being matched against traffic rules.
3.	Source	LAN/VPN/WAN	Match incoming traffic from selected address family only
4.	Destination	LAN/VPN/WAN	Forward incoming traffic to selected address family only
5.	SNAT	Rewrite to source IP 10.101.1.10	SNAT (Source Network Address Translation) rewrite packet's source IP address and port
6.	Enable	Enable/Disable	Make a rule active/inactive

You can configure firewall source NAT rule, by clicking **edit** button.

This page allows you to change advanced properties of the traffic rule entry, such as matched source and destination hosts.

Enable

Name

Protocol

Source zone lan: lan: vpn: openvpn: gre tunnel: wan: wan: ppp:

Source MAC address

Source IP address

Source port

Destination zone lan: lan: vpn: openvpn: gre tunnel: wan: wan: ppp:

Destination IP address

Destination port

SNAT IP address

SNAT port

Extra arguments

1.	Name	SNAT	Used to make rule management easier
2.	Protocol	TCP/UDP/Any/ICMP/Custom	Protocol of the packet that is being matched against traffic rules.
3.	Source zone	LAN/VPN/WAN	Match incoming traffic from this zone only
4.	Source MAC address	any	Match incoming traffic from these MACs only
5.	Source address	any	Match incoming traffic from this IP or range only
6.	Source port	any	Match incoming traffic originating from the given source port or port range on the client host only
7.	Destination zone	LAN/VPN/WAN	Match forwarded traffic to the given destination zone only
8.	Destination IP address	Select from the list	Match forwarded traffic to the given destination IP address or IP range only
9.	Destination port	any	Match forwarded traffic to the given destination port or port range only
10.	SNAT IP address	"10.101.1.10"	Rewrite matched traffic to the given IP address
11.	SNAT port	"22"	Rewrite matched traffic to the given source port. May be left empty to only rewrite the IP address!
12.	Extra arguments		Passes additional arguments to iptables. Use with care!

3.1.2

7.6.5 Custom Rules

Here you have the ultimate freedom in defining your rules – you can enter them straight into the iptables program. Just type them out into the text field and it will get executed as a Linux shell script. If you are unsure of how to use iptables, check out the internet for manuals, examples and explanations.

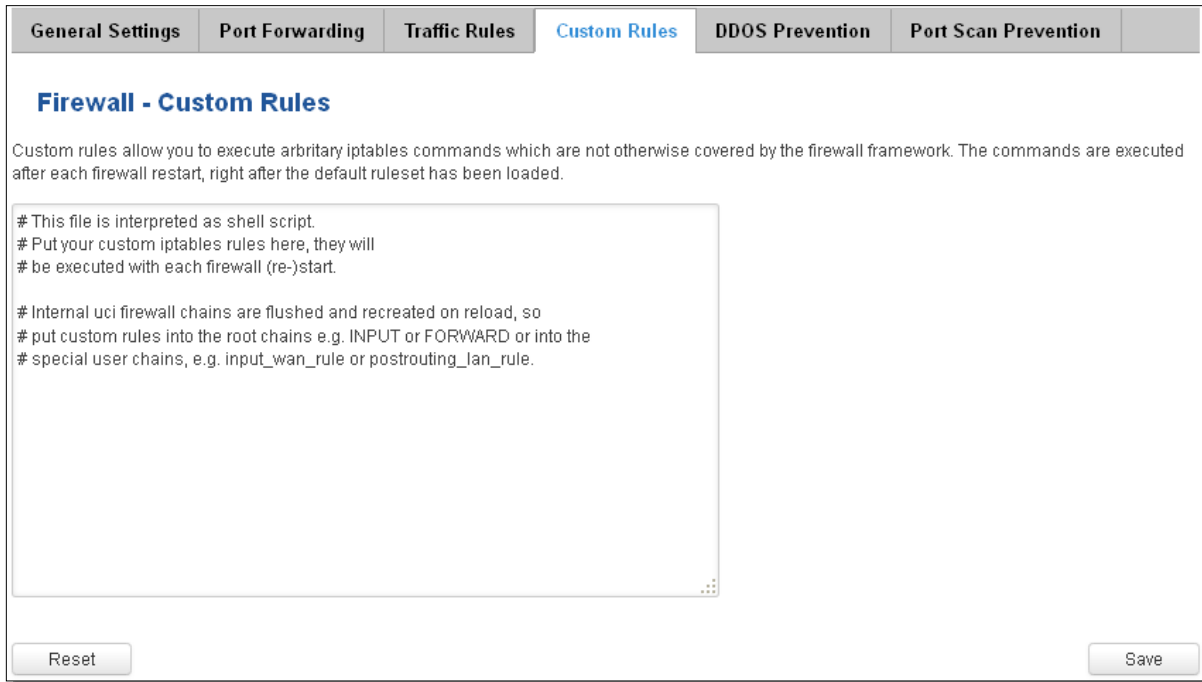

The screenshot shows the 'Firewall - Custom Rules' configuration page. At the top, there are navigation tabs: 'General Settings', 'Port Forwarding', 'Traffic Rules', 'Custom Rules' (selected), 'DDOS Prevention', and 'Port Scan Prevention'. Below the tabs, the page title is 'Firewall - Custom Rules'. A descriptive paragraph states: 'Custom rules allow you to execute arbitrary iptables commands which are not otherwise covered by the firewall framework. The commands are executed after each firewall restart, right after the default ruleset has been loaded.' Below this is a large text area containing a shell script template with the following content:

```
# This file is interpreted as shell script.  
# Put your custom iptables rules here, they will  
# be executed with each firewall (re-)start.  
  
# Internal uci firewall chains are flushed and recreated on reload, so  
# put custom rules into the root chains e.g. INPUT or FORWARD or into the  
# special user chains, e.g. input_wan_rule or postrouting_lan_rule.
```

At the bottom of the page, there are two buttons: 'Reset' on the left and 'Save' on the right.

7.6.6 DDOS Prevention

7.6.6.1 SYN Flood Protection

SYN Flood Protection allows you to protect your router from attacks that exploit part of the normal TCP three-way handshake to consume resources on the targeted server and render it unresponsive. Essentially, with SYN flood DDoS, the offender sends TCP connection requests faster than the targeted machine can process them, causing network saturation.

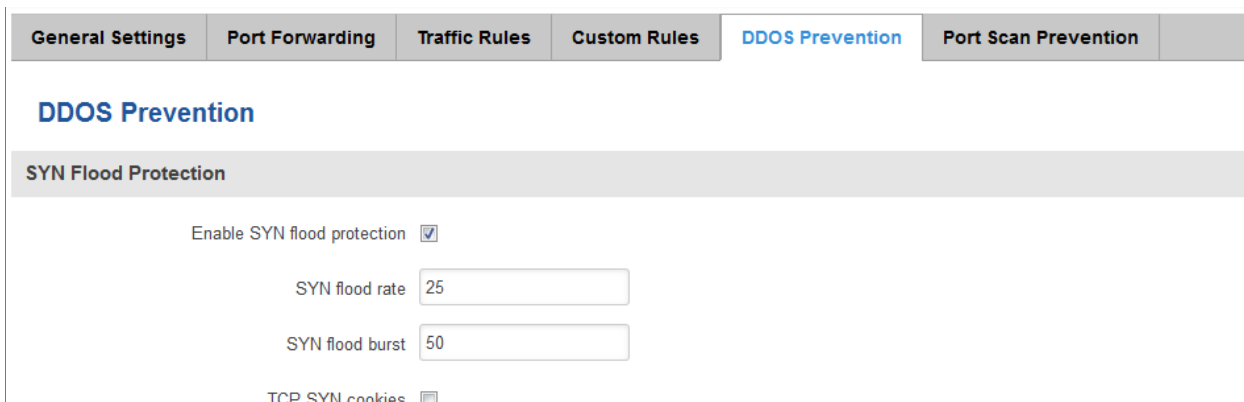

The screenshot shows the 'DDOS Prevention' configuration page. At the top, there are navigation tabs: 'General Settings', 'Port Forwarding', 'Traffic Rules', 'Custom Rules', 'DDOS Prevention' (selected), and 'Port Scan Prevention'. Below the tabs, the page title is 'DDOS Prevention'. Underneath, there is a sub-section titled 'SYN Flood Protection'. The configuration options are:

- 'Enable SYN flood protection' with a checked checkbox
- 'SYN flood rate' with a text input field containing the value '25'
- 'SYN flood burst' with a text input field containing the value '50'
- 'TCP SYN cookies' with an unchecked checkbox

1.	Enable SYN flood protection	Enable/Disable	Makes router more resistant to SYN flood attacks.
2.	SYN flood rate	"25"	Set rate limit (packets/second) for SYN packets above which the traffic is considered flooded.
3.	SYN flood burst	"50"	Set burst limit for SYN packets above which the traffic is considered flooded if it exceeds the allowed rate.
4.	TCP SYN cookies	Enable/Disable	Enable the use of SYN cookies (particular choices of initial TCP sequence numbers by TCP servers).

7.6.6.2 Remote ICMP requests

Attackers are using ICMP echo request packets directed to IP broadcast addresses from remote locations to generate denial-of-service attacks.

Remote ICMP requests

Enable ICMP requests

Enable ICMP limit

Limit period Second ▾

Limit

Limit burst

1.	Enable ICMP requests	Enable/Disable	Blocks remote ICMP echo-request type
2.	Enable ICMP limit	Enable/Disable	Enable ICMP echo-request limit in selected period
3.	Limit period	Second/Minute/Hour/Day	Select in what period limit ICMP echo-request
4.	Limit	"10"	Maximum ICMP echo-requests during the period
5.	Limit burst	"5"	Indicating the maximum burst before the above limit kicks in.

7.6.6.3 SSH Attack Prevention

Prevent SSH (allows a user to run commands on a machine's command prompt without them being physically present near the machine.) attacks by limiting connections in a defined period.

SSH Attack Prevention

Enable SSH limit

Limit period Second ▾

Limit

Limit burst

1.	Enable SSH limit	Enable/Disable	Enable SSH connections limit in selected period
2.	Limit period	Second/Minute/Hour/Day	Select in what period limit SSH connections
3.	Limit	"10"	Maximum SSH connections during the period
4.	Limit burst	"5"	Indicating the maximum burst before the above limit kicks in.

7.6.6.4 HTTP Attack Prevention

HTTP attacks send a complete, legitimate HTTP header, which includes a 'Content-Length' field to specify the size of the message body to follow. However, the attacker then proceeds to send the actual message body at an extremely slow rate (i.e. 1 byte/110 seconds). Due to the entire message being correct and complete, the target server will attempt to obey the 'Content-Length' field in the header, and wait for the entire body of the message to be transmitted, hence slowing it down.

HTTP Attack Prevention

Enable HTTP limit

Limit period Second ▼

Limit

Limit burst

1.	Enable HTTP limit	Enable/Disable	Limits HTTP connections per period
2.	Limit period	Second/Minute/Hour/Day	Select in what period limit HTTP connections
3.	Limit	"10"	Maximum HTTP connections during the period
4.	Limit burst	"10"	Indicating the maximum burst before the above limit kicks in.

7.6.6.5 HTTPS Attack Prevention

HTTPS Attack Prevention

Enable HTTPS limit

Limit period Second ▼

Limit

Limit burst

1.	Enable HTTPS limit	Enable/Disable	Limits HTTPS connections per period
2.	Limit period	Second/Minute/Hour/Day	Select in what period to limit HTTPS connections
3.	Limit	"10"	Maximum HTTPS connections during the period
4.	Limit burst	"10"	Indicating the maximum burst

7.6.7 Port Scan Prevention

7.6.7.1 Port Scan

Port Scan

Enable

Interval

Scan count

1.	Enable	Enable/Disable	Enable port scan prevention
2.	Interval	30	Time interval in seconds counting the length of the scan (10 – 60 sec.)
3.	Scan count	10	How many port scans before blocked

7.6.7.2 Defending type

Defending type

SYN-FIN attack

SYN-RST attack

X-Mas attack

FIN scan

NULLflags attack

1.	SYN-FIN attack	Protect from SYN-FIN attack
2.	SYN-RST attack	Protect from SYN-RST attack
3.	X-Mas attack	Protect from X-Mas attack
4.	FIN scan	Protect from FIN scan
5.	NULLflags attack	Protect from NULLflags attack

3.2

7.7 Routing

7.7.1 Static Routes

Static routes specify over which interface and gateway a certain host or network can be reached.

1.	Routing table	MAIN/WAN/WAN2/WAN3	Defines the table to use for the route
2.	Interface	MAIN/WAN/WAN2/WAN3	The zone where the target network resides
3.	Destination address	IP address	The address of the destination network
4.	Netmask	IP mask	Mask that is applied to the Target to determine what actual IP addresses the routing rule applies
5.	Gateway	IP address	Where the router should send all the traffic that applies to the rule
6.	Metric	integer	Used as a sorting measure. If a packet about to be routed fits two rules, the one with the higher metric is applied.

Additional note on Target & Netmask: You can define a rule that applies to a single IP like this: Target - some IP; Netmask - 255.255.255.255. Furthermore you can define a rule that applies to a segment of IPs like this: Target – an IP that STARTS the segment; Netmask – Netmask that defines how large the segment is. E.g.:

192.168.55.161	255.255.255.255	Only applies to 192.168.55.161
192.168.55.0	255.255.255.0	Applies to IPs in range 192.168.55.0-192.168.55.255
192.168.55.240	255.255.255.240	Applies 192.168.55.240 - 192.168.55.255
192.168.55.161	255.255.255.0	192.168.55.0 - 192.168.55.255
192.168.0.0	255.255.0.0	192.168.0.0 - 192.168.255.255

7.7.2 Dynamic Routes

7.7.2.1 General

Dynamic routes provide dynamic routing which enables the router to select paths according to real-time logical network layout changes.

1.	Enable	Enable/Disable	Enable dynamic routes
2.	Router ID	192.168.1.1	Router's ID

7.7.2.2 OSPF Protocol

7.7.2.2.1 OSPF General Instance

1.	Enable	Enable/Disable	Enables OSPF protocol
2.	Stub	Enable/Disable	Enable/Disable stub
3.	RFC1583 compatibility	Enable/Disable	Enables OSPF compatibility with RFC1583 specification
4.	Import	All/None/custom	Set if the protocol must import routes
5.	Export	All/None/custom	Set if the protocol must export routes

7.7.2.2 OSPF Area

The OSPF network can be divided into sub-domains called areas.

OSPF Area	
Area name	Enable
OSPF_area	No

New area name:

1.	Area name	OSPF_area	OSPF area's name
2.	Enable	Yes/No	Enable/disable OSPF area

To see at specific configuration settings press **“edit”** button located in newly created OSPF area. A new page with detailed configuration appears, as shown in the picture below.

Area Instance: OSPF_area

Main Settings

Enabled

Stub

OSPF interface

Interface

There are no interfaces created yet

Interface:

OSPF networks

IP

Hidden

There are no networks created yet

New IP:

1.	Enabled	Enable/Disable	Enable specific OSPF area
2.	Stub	Enable/Disable	Enable/disable stub
3.	Interface	br-lan	The interface that the new instance will have
4.	New IP		Name of the new OSPF network configuration. Used for easier configuration management purpose only

7.7.2.3 General Protocol

The screenshot shows the 'General Protocols Configuration' window. At the top, there are tabs for 'General', 'OSPF Protocol', and 'General Protocols'. The main title is 'General Protocols Configuration'. Below this, there are two sections: 'Kernel Options' and 'Device Options'. In the 'Kernel Options' section, there are three checkboxes: 'Enable', 'Learn', and 'Persist', all of which are currently unchecked. Below these is a 'Scan time' input field with the value '20'. There are also two dropdown menus: 'Import' and 'Export', both set to 'All'. In the 'Device Options' section, there is an 'Enable' checkbox (unchecked) and a 'Scan time' input field with the value '10'.

1.	Enable	Enable/Disable	Enable/Disable settings
2.	Learn	Enable/Disable	Enables route learning
3.	Persist	Enable/Disable	If checked it allows route storing. After a restart, routes will still be configured
4.	Scan time	20	Time between scans
5.	Import	All	Set if the protocol must import routes
6.	Export	All	Set if the protocol must export routes
7.	Enable	Enable/Disable	If checked the protocol will not be configured
8.	Scan time	10	Time between scans

7.7.2.3.1 Static Routes

The screenshot shows the 'Static Routes' configuration window. At the top, it says 'Static Routes'. Below this is a table with two columns: 'Prefix' and 'Type'. The table is currently empty, with the text 'There are no static routes created yet' below it. Below the table is a section for 'New Static Route'. It has two input fields: 'Prefix' and 'Type'. The 'Type' dropdown menu is currently set to 'Router'. There is an 'Add' button to the right of the 'Type' dropdown. At the bottom right of the window, there is a 'Save' button.

1.	Prefix	Protocol prefix of an incoming or outgoing packet
2.	Type	Protocol type of an incoming or outgoing packet

8 Services

8.1 VRRP

8.1.1 VRRP LAN Configuration Settings

VRRP LAN Configuration Settings

Enable

IP address 

Virtual ID

Priority

1.	Enable	Enable/Disable	Enable VRRP (Virtual Router Redundancy Protocol) for LAN
2.	IP address	192.168.1.253	Virtual IP address for LAN's VRRP (Virtual Router Redundancy Protocol) cluster
3.	Virtual ID	1	Routers with same IDs will be grouped in the same VRRP (Virtual Router Redundancy Protocol) cluster, range [1-255]
4.	Priority	100	Router with highest priority value on the same VRRP (Virtual Router Redundancy Protocol) cluster will act as a master, range [1-255]

8.1.2 Check Internet connection

Check internet connection

Enable

Ping IP address

Ping interval

Ping timeout (sec)

Ping packet size

Ping retry count

1.	Enable	Enable/Disable	Enable WAN's connection monitoring
2.	Ping IP address	8.8.4.4	A host to send ICMP (Internet Control Message Protocol) packets to
3.	Ping interval	10	Time interval in seconds between two Pings
4.	Ping timeout (sec)	1	Response timeout value, interval [1 - 9999]
5.	Ping packet size	50	ICMP (Internet Control Message Protocol) packet's size, interval [0 - 1000]
6.	Ping retry count	100	Failed Ping attempt's count before determining that connection is lost, interval [1 - 9999]

8.2 Web Filter

8.2.1 Site blocking

Site Blocking Settings

Site Blocking

Enable

Mode Whitelist ▾

Enable	Host name
<input checked="" type="checkbox"/>	www.yahoo.com Delete

Add

1.	Enable	Enable/Disable	Enable host name based websites blocking
2.	Mode	Whitelist/Blacklist	Whitelist - allow every site on the list and block everything else. Blacklist - block every site on the list and allow everything else.
3.	Enable	Enable/Disable	Check to enable site blocking
4.	Host name	www.yahoo.com	Block/allow site with this hostname

8.2.2 Proxy Based Content Blocker

Proxy Based URL Content Blocker Configuration

Proxy Based URL Content Blocker

Enable

Mode Blacklist ▾

URL Filter Rules

Enable	URL content
<input checked="" type="checkbox"/>	example.com Delete

1.	Enable	Enable/Disable	Enable proxy server based URL content blocking. Works with HTTP protocol only
2.	Mode	Whitelist/Blacklist	Whitelist - allow every part of URL on the list and block everything else. Blacklist - block every part of URL on the list and allow everything else
3.	URL content	example.com	Block/allow any URL containing this string. Example.com, example.*, *.example.com

8.3 NTP

NTP configuration lets you setup and synchronize routers time.

1.	Current System time	Local time of router.
2.	Time zone	Time zone of your country.
3.	Enable NTP	Enable system's time synchronization with time server using NTP (Network Time Protocol)
4.	Update interval	How often router updates systems time
5.	Save time to flash	Save last synchronized time to flash memory
6.	Count of time synchronizations	Total amount of times that router will do the synchronization. Note: If left blank - the count will be infinite
7.	Offset frequency	Adjust the minor drift of the clock so that it will be more accurate

Note, that under **Time Servers** at least one server has to be present, otherwise NTP will not serve its purposes.

8.4 VPN

8.4.1 OpenVPN

VPN (Virtual Private Network) is a method for secure data transfer through unsafe public network. This section explains how to configure OpenVPN, which is implementation of VPN supported by the RUT900 router.

A picture below demonstrates default OpenVPN configurations list, which is empty, so you have to define a new configuration to establish any sort of OpenVPN connection. To create it, enter desired configuration name in “**New configuration name**” field, select device role from “**Role**” drop down list. For example, to create an OpenVPN client with configuration name demo, select client role, name it “demo” and press “**Add New**” button as shown in the following picture.

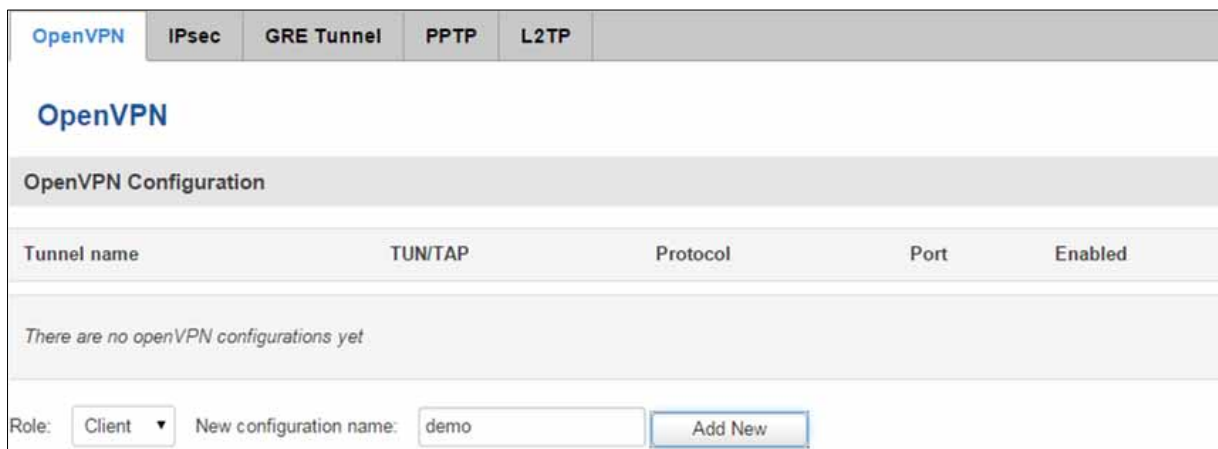

The screenshot shows the OpenVPN configuration interface. At the top, there are tabs for 'OpenVPN', 'IPsec', 'GRE Tunnel', 'PPTP', and 'L2TP'. Below the tabs, the title 'OpenVPN' is displayed. Underneath, there is a section titled 'OpenVPN Configuration'. A table with the following headers is shown: Tunnel name, TUN/TAP, Protocol, Port, and Enabled. Below the table, a message states: 'There are no openVPN configurations yet.' At the bottom, there is a form with a 'Role:' dropdown menu set to 'Client', a 'New configuration name:' text input field containing 'demo', and an 'Add New' button.

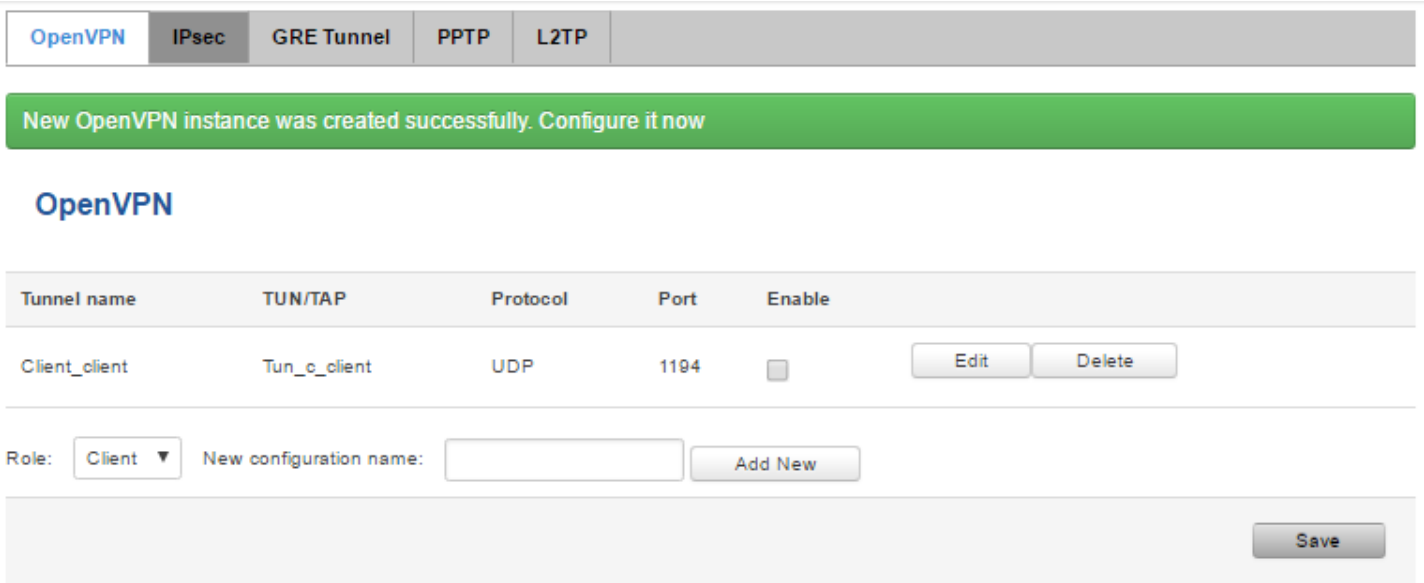

The screenshot shows the OpenVPN configuration interface after a new instance has been created. At the top, there are tabs for 'OpenVPN', 'IPsec', 'GRE Tunnel', 'PPTP', and 'L2TP'. Below the tabs, a green notification bar states: 'New OpenVPN instance was created successfully. Configure it now'. Underneath, the title 'OpenVPN' is displayed. A table with the following headers is shown: Tunnel name, TUN/TAP, Protocol, Port, and Enable. Below the table, a message states: 'There are no openVPN configurations yet.' At the bottom, there is a form with a 'Role:' dropdown menu set to 'Client', a 'New configuration name:' text input field, and an 'Add New' button. A 'Save' button is also visible at the bottom right.

To see at specific configuration settings press “**edit**” button located in newly created configuration entry. A new page with detailed configuration appears, as shown in the picture below (TLS client example).

OpenVPN Instance: Client_client

Main Settings

Enable	<input checked="" type="checkbox"/>
TUN/TAP	TUN (tunnel) ▼
Protocol	UDP ▼
Port	1194
LZO	<input type="checkbox"/>
Encryption	BF-CBC 128 (default) ▼
Authentication	TLS ▼
TLS cipher	All ▼
Remote host/IP address	84.15.199.20
Resolve retry	infinite
Keep alive	10 120
Remote network IP address	10.0.0.0
Remote network IP netmask	255.255.255.0
Max routes	100
Extra options	<input type="text"/>
HMAC authentication algorithm	SHA1 (default) ▼
Additional HMAC authentication	<input type="checkbox"/>
Certificate authority	<input type="button" value="Choose File"/> No file chosen
Client certificate	<input type="button" value="Choose File"/> No file chosen
Client key	<input type="button" value="Choose File"/> No file chosen

You can set custom settings here according to your VPN needs. Below is summary of parameters available to set:

1.	Enabled	Switches configuration on and off. This must be selected to make configuration active.
2.	TUN/TAP	Selects virtual VPN interface type. TUN is most often used in typical IP-level VPN connections, however, TAP is required to some Ethernet bridging configurations.
3.	Protocol	Defines a transport protocol used by connection. You can choose here between TCP and UDP.
4.	Port	Defines TCP or UDP port number (make sure, that this port allowed by firewall).
5.	LZO	This setting enables LZO compression. With LZO compression, your VPN connection will generate less network traffic; however, this means higher router CPU loads. Use it carefully with high rate traffic or low CPU resources.
6.	Encryption	Selects Packet encryption algorithm.
7.	Authentication	Sets authentication mode, used to secure data sessions. Two possibilities you have here: "Static key" means, that OpenVPN client and server will use the same secret key, which must be uploaded to the router using "Static pre-shared key" option. "TLS" authentication mode uses X.509 type certificates. Depending on your selected OpenVPN mode (client or server) you have to upload these certificates to the router: For client: Certificate Authority (CA), Client certificate, Client key. For server: Certificate Authority (CA), Server certificate, Server key and Diffie-Hellman (DH) certificate used to key exchange through unsafe data networks. All mention certificates can be generated using OpenVPN or Open SSL utilities on any type host machine. Certificate generation and theory is out of scope of this user manual.
8.	TLS cipher	Packet encryption algorithm (cipher)
9.	Remote host/IP address	IP address of OpenVPN server (applicable only for client configuration).
10.	Resolve Retry	Sets time in seconds to try resolving server hostname periodically in case of first resolve failure before generating service exception.
11.	Keep alive	Defines two time intervals: one is used to periodically send ICMP request to OpenVPN server, and another one defines a time window, which is used to restart OpenVPN service, if no ICMP request is received during the window time slice. Example Keep Alive "10 60"
12.	Remote network IP address	IP address of remote network, an actual LAN network behind another VPN endpoint.
13.	Remote network IP netmask	Subnet mask of remote network, an actual LAN network behind another VPN endpoint.
14.	Max routes	Allow a maximum number of routes to be pulled from an OpenVPN server
15.	HMAC authentication algorithm	Sets HMAC authentication algorithm
16.	Additional HMAC authentication	Add an additional layer of HMAC authentication on top of the TLS control channel to protect against DoS attacks
17.	Certificate authority	Certificate authority is an entity that issues digital certificates. A digital certificate certifies the ownership of a public key by the named subject of the certificate.
18.	Client certificate	Client certificate is a type of digital certificate that is used by client systems to make authenticated requests to a remote server. Client certificates play a key role in many mutual authentication designs, providing strong assurances of a requester's identity.
19.	Client key	Authenticating the client to the server and establishing precisely who they are

After setting any of these parameters press **"Save"** button. Some of selected parameters will be shown in the configuration list table. You should also be aware of the fact that router will launch separate OpenVPN service for every

configuration entry (if it is defined as active, of course) so the router has ability to act as server and client at the same time.

8.4.2 IPsec

The IPsec protocol client enables the router to establish a secure connection to an IPsec peer via the Internet. IPsec is supported in two modes - transport and tunnel. Transport mode creates secure point to point channel between two hosts. Tunnel mode can be used to build a secure connection between two remote LANs serving as a VPN solution.

IPsec system maintains two databases: Security Policy Database (SPD) which defines whether to apply IPsec to a packet or not and specify which/how IPsec-SA is applied and Security Association Database (SAD), which contain Key of each IPsec-SA.

The establishment of the Security Association (IPsec-SA) between two peers is needed for IPsec communication. It can be done by using manual or automated configuration.

Note: router starts establishing tunnel when data from router to remote site over tunnel is sent. For automatic tunnel establishment used tunnel Keep Alive feature.

IPsec Configuration

Enable

IKE version

Mode

My identifier type

My identifier

Dead Peer Detection

Pre shared key

Remote VPN endpoint

IP address/Subnet mask 

Enable keepalive

Host

Ping period (sec)

1.	Enable	Enabled/Disabled	Check box to enable IPsec.
2.	IKE version	IKEv1 or IKEv2	Method of key exchange
3.	Mode	“Main” or “Aggressive”	ISAKMP (Internet Security Association and Key Management Protocol) phase 1 exchange mode
4.	My identifier type	Address, FQDN, User FQDN	Choose one accordingly to your IPsec configuration
5.	My identifier		Set the device identifier for IPsec tunnel. In case RUT has Private IP, its identifier should be its own LAN network address. In this way, the Road Warrior approach is possible.
6.	Dead Peer Detection	Enabled/Disabled	The values clear, hold and restart all active DPD
7.	Pre shared key		A shared password to authenticate between the peer
8.	Remote VPN endpoint		Domain name or IP address. Leave empty or any
9.	IP address/Subnet mask		Remote network secure group IP address and mask used to determine to what subnet an IP address belongs to. Range [0-32]. IP should differ from device LAN IP
10.	Enable keep alive	Enabled/Disabled	Enable tunnel keep alive function
11.	Host		A host address to which ICMP (Internet Control Message Protocol) echo requests will be send
12.	Ping period (sec)		Send ICMP echo request every x seconds. Range [0-999999]

Phase 1 and **Phase 2** must be configured accordingly to the IPsec server configuration, thus algorithms, authentication and lifetimes of each phase must be identical.

Phase

The phase must match with another incoming connection to establish IPsec

Phase 1 **Phase 2**

Encryption algorithm: 3DES

Authentication: SHA1

DH group: MODP1536

Lifetime (h): 8 Minutes

Phase

The phase must match with another incoming connection to establish IPsec

Phase 1 **Phase 2**

Encryption algorithm 3DES ▾

Hash algorithm SHA1 ▾

PFS group MODP1536 ▾

Lifetime (h) 8 Hours ▾

1.	Encryption algorithm	DES, 3DES, AES 128, AES 192, AES256	The encryption algorithm must match with another incoming connection to establish IPsec
2.	Authentication	MD5, SHA1, SHA256, SHA384, SHA512	The authentication algorithm must match with another incoming connection to establish IPsec
3.	Hash algorithm	MD5, SHA1, SHA256, SHA384, SHA512	The hash algorithm must match with another incoming connection to establish IPsec
4.	DH group	MODP768, MODP1024, MODP1536, MODP2048, MODP3072, MODP4096	The DH (Diffie-Helman) group must with another incoming connection to establish IPsec
4.	PFS group	MODP768, MODP1024, MODP1536, MODP2048, MODP3072, MODP4096, No PFS	The PFS (Perfect Forward Secrecy) group must match with another incoming connection to establish IPsec
5.	Lifetime	Hours, Minutes, Seconds	The time duration for phase

3.2.1

8.4.3 GRE Tunnel

GRE (Generic Routing Encapsulation RFC2784) is a solution for tunneling RFC1812 private address-space traffic over an intermediate TCP/IP network such as the Internet. GRE tunneling does not use encryption it simply encapsulates data and sends it over the WAN.

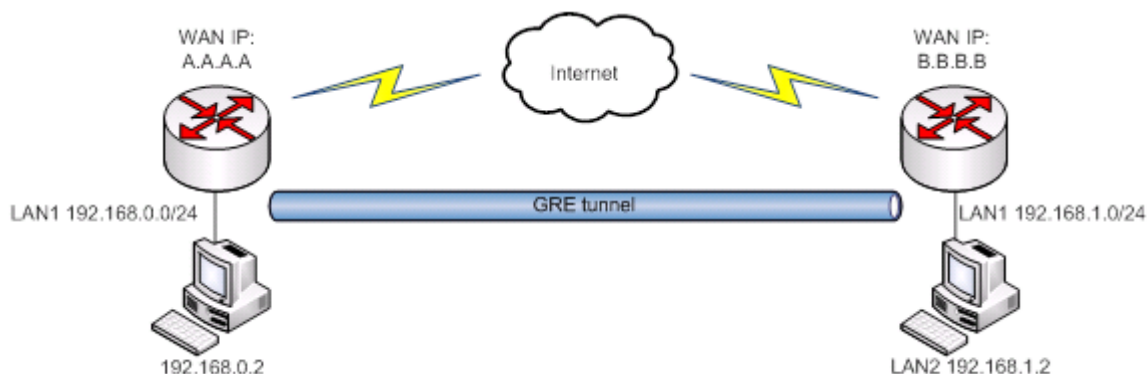

In the example network diagram two distant networks LAN1 and LAN2 are connected.

To create GRE tunnel the user must know the following parameters:

1. Source and destination IP addresses.
2. Tunnel local IP address
3. Distant network IP address and Subnet mask.

OpenVPN	IPsec	GRE Tunnel	PPTP	L2TP
Gre-tunnel Instance: Gre_tunnel				
Main Settings				
Enabled <input checked="" type="checkbox"/>				
Remote endpoint IP address	84.148.7.87			
Remote network	192.168.2.0			
Remote network netmask	24			
Local tunnel IP	10.0.0.1			
Local tunnel netmask	24			
MTU	1500			
TTL	255			
PMTUD <input checked="" type="checkbox"/>				
Enable Keep alive <input checked="" type="checkbox"/>				
Keep Alive host	<input type="text"/>			
Keep Alive interval	<input type="text"/>			

1.	Enabled	Check the box to enable the GRE Tunnel function.
2.	Remote endpoint IP address	Specify remote WAN IP address.
3.	Remote network	IP address of LAN network on the remote device.
4.	Remote network netmask	Network of LAN network on the remote device. Range [0-32].
5.	Local tunnel IP	Local virtual IP address. Cannot be in the same subnet as LAN network.
6.	Local tunnel netmask	Network of local virtual IP address. Range [0-32]
7.	MTU	Specify the maximum transmission unit (MTU) of a communications protocol of a layer in bytes.
8.	TTL	Specify the fixed time-to-live (TTL) value on tunneled packets [0-255]. The 0 is a special value meaning that packets inherit the TTL value.
9.	PMTUD	Check the box to enable the Path Maximum Transmission Unit Discovery (PMTUD) status on this tunnel.
10.	Enable Keep alive	It gives the ability for one side to originate and receive keep alive packets to and from a remote router even if the remote router does not support GRE keep alive.
11.	Keep Alive host	Keep Alive host IP address. Preferably IP address which belongs to the LAN network on the remote device.
12.	Keep Alive interval	Time interval for Keep Alive. Range [0 - 255].

8.4.4 PPTP

Point-to-Point Tunneling Protocol (PPTP) is a protocol (set of communication rules) that allows corporations to extend their own corporate network through private "tunnels" over the public Internet. Effectively, a corporation uses a wide-area network as a single large local area network. A company no longer needs to lease its own lines for wide-area communication but can securely use the public networks. This kind of interconnection is known as a virtual private network (VPN).

OpenVPN IPsec GRE Tunnel **PPTP** L2TP

PPTP Server Instance: Server

Main Settings

Enable

Local IP

Remote IP range start

Remote IP range end

User name	Password	User IP	
<input type="text" value="youruser"/>	<input type="password" value="*****"/>	<input type="text"/>	<input type="button" value="Delete"/>

1.	Enable	Check the box to enable the PPTP function.
2.	Local IP	IP Address of this device (RUT)
3.	Remote IP range begin	IP address leases beginning
4.	Remote IP range end	IP address leases end
5.	Username	Username to connect to PPTP (this) server
6.	Password	Password to connect to PPTP server
7.	User IP	Users IP address

PPTP Client Instance: Client

Main Settings

Enable

Use as default gateway

Server

User name

Password 

[Back to Overview](#) [Save](#)

1.	Enable	Enable current configuration
2.	Use as default gateway	Use this PPTP instance as default gateway
3.	Server	The server IP address or hostname
4.	Username	The user name for authorization with the server
5.	Password	The password for authorization with the server

3.2.2

8.4.5 L2TP

Allows setting up a L2TP server or client. Below is L2TP server configuration example.

OpenVPN IPsec GRE Tunnel PPTP **L2TP**

L2TP Server Instance: Server

Main Settings

Enable

Local IP

Remote IP range begin

Remote IP range end

User name	Password	
<input type="text" value="user"/>	<input type="password" value="****"/>	<input type="button" value="Delete"/>

1.	Enable	Check the box to enable the L2TP Tunnel function.
2.	Local IP	IP Address of this device (RUT)
3.	Remote IP range begin	IP address leases beginning
4.	Remote IP range end	IP address leases end
5.	Username	Username to connect to L2TP (this) server
6.	Password	Password to connect to L2TP server

Client configuration is even simpler, which requires only **Servers IP**, **Username** and **Password**.

L2TP Server Instance: Server

Main Settings

Enable

Local IP

Remote IP range begin

Remote IP range end

User name	Password	
<input type="text" value="user"/>	<input type="password" value="****"/>	<input type="button" value="Delete"/>

8.5 Dynamic DNS

Dynamic DNS (DDNS) is a domain name service allowing to link dynamic IP addresses to static hostname.

To start using this feature firstly you should register to DDNS service provider (example list is given in description).

You are provided with add/delete buttons to manage and use different DDNS configurations at the same time!

You can configure many different DDNS Hostnames in the main DDNS Configuration section.

DDNS

DDNS Configuration

DDNS name	Hostname	Status	Enable	
Myddns	yourhost.example.org	N/A	<input type="checkbox"/>	<input type="button" value="Edit"/> <input type="button" value="Delete"/>

New configuration name:

To edit your selected configuration, hit **Edit**.

DDNS

Enable

Status N/A

Service

Hostname

User name

Password 

IP source

Network

IP renew interval (min)

Force IP renew (min)

1.	Enable	Enable/Disable	Enables current DDNS configuration.
2.	Status		Timestamp of the last IP check or update.
3.	Service	1. dydns.org 2. 3322.org 3. no-ip.com 4. easydns.com 5. zoneedit.com	Your dynamic DNS service provider selected from the list. In case your DDNS provider is not present from the ones provided, please feel free to use "custom" and add hostname of the update URL.
4.	Hostname	yourhost.example.org	Domain name which will be linked with dynamic IP address.
5.	Username	your_username	Name of the user account.
6.	Password	your_password	Password of the user account.
7.	IP Source	Public Private Custom	This option allows you to select specific RUT interface, and then send the IP address of that interface to DDNS server. So if, for example, your RUT has Private IP (i.e. 10.140.56.57) on its WAN (3G interface), then you can send this exact IP to DDNS server by selecting "Private", or by selecting "Custom" and "WAN" interface. The DDNS server will then resolve hostname queries to this specific IP.
8.	Network	WAN	Source network
9.	IP renew interval (min)	10 (minutes)	Time interval (in minutes) to check if the IP address of the device have changed.
10.	Force IP renew	472 (minutes)	Time interval (in minutes) to force IP address renew.

3.3

8.6 SMS Utilities

RUT230 has extensive amount of various SMS Utilities. These are subdivided into 6 sections: SMS Utilities, Call Utilities, User Groups, SMS Management, Remote Configuration and Statistics.

8.6.1 SMS Utilities

SMS Utilities					
SMS Rules					
Action	SMS Text	Enable	Sort		
Reboot	reboot	<input checked="" type="checkbox"/>	↕	Edit	Delete
Get status	status	<input checked="" type="checkbox"/>	↕	Edit	Delete
Get OpenVPN status	vpnstatus	<input checked="" type="checkbox"/>	↕	Edit	Delete
Switch WiFi on	wifion	<input checked="" type="checkbox"/>	↕	Edit	Delete

All configuration options are listed below:

- Reboot
- Get status
- Get OpenVPN status
- Switch WiFi on/off
- Switch mobile data on/off
- Switch OpenVPN on/off
- Change mobile data settings
- Get list of profiles
- Change profile
- Manage OpenVPN
- SSH access control
- Web access control
- Restore to default
- Force SIM switch
- FW upgrade from server
- Config update from server

- Switch monitoring on/off
- Get Monitoring status
- UCI parameters

You can choose your SMS Keyword (text to be sent) and authorized phone number in the main menu. You can edit each created rule by hitting **Edit** button.

1.	Reboot		
	Enable	This check box will enable and disable SMS reboot function.	Allows router restart via SMS.
	Action	The action to be performed when this rule is met.	
	SMS text	SMS text which will reboot router.	SMS text can contain letters, numbers, spaces and special symbols. Capital letters also matters.
	Authorization method	What kind of authorization to use for SIM management.	No authorization, by serial or by router admin password.
	Allowed users	Whitelist of allow users	From all numbers, from group or from single number.
	Get status via SMS after reboot	Check this to receive connection status via SMS after a reboot.	If you select this box, router will send status once it has rebooted and is operational again. This is both separate SMS Rule and an option under SMS Reboot rule.

	Message text	Which status information should be included in SMS: Data state, Operator, Connection type, Signal Strength, Connection State, IP	You can select which status elements to display.
2.	Get status		
	Enable	Check this to receive connection status via SMS.	Allows to get router's status via SMS. This is both separate SMS Rule and an option under SMS Reboot rule.
	Action	The action to be performed when this rule is met.	
	Enable SMS Status	This check box will enable and disable SMS status function.	SMS status is disabled by default.
	SMS text	SMS text which will send routers status.	SMS text can contain letters, numbers, spaces and special symbols. Capital letters also matters.
	Authorization method	What kind of authorization to use for SIM management.	No authorization, by serial or by router admin password.
	Allowed users	Whitelist of allow users	From all numbers, from group or from single number.
	Message text	Which status information should be included in SMS: Data state, Operator, Connection type, Signal Strength, Connection State, IP	You can select which status elements to display.
3.	Get OpenVPN status		
	Enable	This check box will enable and disable this function.	Allows to get OpenVPN's status via SMS.
	Action	The action to be performed when this rule is met.	
	SMS text	SMS text which will send OpenVPN status.	SMS text can contain letters, numbers, spaces and special symbols. Capital letters also matters.
	Authorization method	What kind of authorization to use for SIM management.	No authorization, by serial or by router admin password.
	Allowed users	Whitelist of allow users	From all numbers, from group or from single number.
4.	Switch WiFi On/Off		
	Enable	This check box will enable and disable this function.	Allows WiFi control via SMS.
	Action	The action to be performed when this rule is met.	Turn WiFi ON or OFF.
	SMS text	SMS text which will turn WiFi ON/OFF.	SMS text can contain letters, numbers, spaces and special symbols. Capital letters also matters.
	Authorization method	What kind of authorization to use for SIM management.	No authorization, by serial or by router admin password.
	Allowed users	Whitelist of allow users	From all numbers, from group or from single number.
	Write to config	Permanently saves WiFi state.	With this setting enabled, router will keep WiFi state even after reboot. If it is not selected, router will revert WiFi state after reboot.
5.	Switch mobile data on/off		

	Enable	This check box will enable and disable this function.	Allows mobile control via SMS.
	Action	The action to be performed when this rule is met.	Turn mobile ON or OFF.
	SMS text	SMS text which will turn mobile data ON/OFF.	SMS text can contain letters, numbers, spaces and special symbols. Capital letters also matters.
	Authorization method	What kind of authorization to use for SIM management.	No authorization, by serial or by router admin password.
	Allowed users	Whitelist of allow users	From all numbers, from group or from single number.
	Write to config	Permanently saves mobile network state.	With this setting enabled, router will keep mobile state even after reboot. If it is not selected, router will revert mobile state after reboot.
6.	Manage OpenVPN		
	Enable	This check box will enable and disable this function.	Allows OpenVPN control via SMS.
	Action	The action to be performed when this rule is met.	Turn OpenVPN ON or OFF.
	SMS text	Keyword which will turn OpenVPN ON/OFF.	SMS text can contain letters, numbers, spaces and special symbols. Capital letters also matters. After Keyword you have to write OpenVPN name.
	Authorization method	What kind of authorization to use for SIM management.	No authorization, by serial or by router admin password.
	Allowed users	Whitelist of allow users	From all numbers, from group or from single number.
7.	Change mobile data settings		
	Enable	This check box will enable and disable this function.	Allows to change mobile settings via SMS.
	Action	The action to be performed when this rule is met.	
	SMS text	Key word that will precede actual configuration parameters.	SMS text can contain letters, numbers, spaces and special symbols. Capital letters also matters.
	Authorization method	What kind of authorization to use for SIM management.	No authorization, by serial or by router admin password.
	Allowed users	Whitelist of allow users	From all numbers, from group or from single number.

Mobile Settings via SMS parameters:

1.	apn=	e.g. internet.gprs	Sets APN. i.e: apn=internet.gprs
2.	dialnumber=	e.g. *99***1#	Sets dial number
3.	auth_mode=	none pap chap	Sets authentication mode
4.	service=	Auto 3gonly 2gonly	You can add as many phone numbers as you need. Dropdown list with additional rows will show up if you click on "add" icon at the end of phone number row.
5.	username=	user	Used only if PAP or CHAP authorization is selected

6.	password=	user	Used only if PAP or CHAP authorization is selected
----	-----------	------	----------------------------------------------------

All Mobile settings can be changed in one SMS. Between each <parameter=value> pair a space symbol is necessary.

Example: *cellular apn=internet.gprs dialnumber=*99***1#auth_mode=pap service=3gonly username=user password=user*

Important Notes:

- 3G settings must be configured correctly. If SIM card has PIN number you must enter it at “Network” > “3G” settings. Otherwise SMS reboot function will not work.
- Sender phone number must contain country code. You can check sender phone number format by reading the details of old SMS text messages you receiving usually.

8.	Get list of profiles		
	Enable	This check box will enable and disable this function.	Allows to get list of profiles via SMS.
	Action	The action to be performed when this rule is met.	
	SMS text	SMS text which will send list of profiles.	SMS text can contain letters, numbers, spaces and special symbols. Capital letters also matters.
	Authorization method	What kind of authorization to use for SIM management.	No authorization, by serial or by router admin password.
	Allowed users	Whitelist of allow users	From all numbers, from group or from single number.
9.	Change profile		
	Enable	This check box will enable and disable this function.	Allows profile change via SMS.
	Action	The action to be performed when this rule is met.	
	SMS text	Keyword which will change active profile.	SMS text can contain letters, numbers, spaces and special symbols. Capital letters also matters. After Keyword you have to write profile name.
	Authorization method	What kind of authorization to use for SIM management.	No authorization, by serial or by router admin password.
	Allowed users	Whitelist of allow users	From all numbers, from group or from single number.
10.	SSH access Control		
	Enable	This check box will enable and disable this function.	Allows SSH access control via SMS.
	Action	The action to be performed when this rule is met.	
	SMS text	SMS text which will turn SSH access ON/OFF.	SMS text can contain letters, numbers, spaces and special symbols. Capital letters also matters.
	Authorization method	What kind of authorization to use for SIM management.	No authorization, by serial or by router admin password.

	Allowed users	Whitelist of allow users	From all numbers, from group or from single number.
	Enable SSH access	Enable this to reach router via SSH from LAN (Local Area Network).	If this box is selected, SMS will enable SSH access from LAN. If this box is not selected, SMS will disable SSH access from LAN.
	Enable remote SSH access	Enable this to reach router via SSH from WAN (Wide Area Network).	If this box is selected, SMS will enable SSH access from WAN. If this box is not selected, SMS will disable SSH access from WAN.
11.	Web access Control		
	Enable	This check box will enable and disable this function.	Allows Web access control via SMS.
	Action	The action to be performed when this rule is met.	
	SMS text	SMS text which will turn Web access ON/OFF.	SMS text can contain letters, numbers, spaces and special symbols. Capital letters also matters.
	Authorization method	What kind of authorization to use for SIM management.	No authorization, by serial or by router admin password.
	Allowed users	Whitelist of allow users	From all numbers, from group or from single number.
	Enable HTTP access	Enable this to reach router via HTTP from LAN (Local Area Network).	If this box is selected, SMS will enable HTTP access from LAN. If this box is not selected, SMS will disable HTTP access from LAN.
	Enable remote HTTP access	Enable this to reach router via HTTP from WAN (Wide Area Network).	If this box is selected, SMS will enable HTTP access from WAN. If this box is not selected, SMS will disable HTTP access from WAN.
	Enable remote HTTPS access	Enable this to reach router via HTTPS from WAN (Wide Area Network).	If this box is selected, SMS will enable HTTPS access from WAN. If this box is not selected, SMS will disable HTTPS access from WAN.
12.	Restore to default		
	Enable	This check box will enable and disable this function.	Allows to restore router to default settings via SMS.
	Action	The action to be performed when this rule is met.	Router will reboot after this rule is executed.
	SMS text	SMS text which will turn WiFi ON/OFF.	SMS text can contain letters, numbers, spaces and special symbols. Capital letters also matters.
	Authorization method	What kind of authorization to use for SIM management.	No authorization, by serial or by router admin password.
	Allowed users	Whitelist of allow users	From all numbers, from group or from single number.
13.	Force switch SIM		
	Enable	This check box will enable and disable this function.	Allows SIM switch via SMS.
	Action	The action to be performed when this rule is met.	
	SMS text	SMS text which will change active SIM card to another one.	SMS text can contain letters, numbers, spaces and special symbols. Capital letters also matters.
	Authorization method	What kind of authorization to use for SIM management.	No authorization, by serial or by router admin password.
	Allowed users	Whitelist of allow users	From all numbers, from group or from single number.
	Sender phone number	Phone number of person who can receive router status via SMS message.	You can add as many phone numbers as you need. Dropdown list with additional rows will show up if you click on "add" icon at the end of phone number row.

14.	Force FW upgrade from server		
	Enable	This check box will enable and disable this function.	Allows to upgrade router's FW via SMS.
	Action	The action to be performed when this rule is met.	Router will reboot after this rule is executed.
	SMS text	SMS text which will force router to upgrade firmware from server.	SMS text can contain letters, numbers, spaces and special symbols. Capital letters also matters.
	Authorization method	What kind of authorization to use for SIM management.	No authorization, by serial or by router admin password.
	Allowed users	Whitelist of allow users	From all numbers, from group or from single number.
15.	Force Config update from server		
	Enable	This check box will enable and disable this function.	Allows to upgrade router's Config via SMS.
	Action	The action to be performed when this rule is met.	Router will reboot after this rule is executed.
	SMS text	SMS text which will force router to upgrade configuration from server.	SMS text can contain letters, numbers, spaces and special symbols. Capital letters also matters.
	Authorization method	What kind of authorization to use for SIM management.	No authorization, by serial or by router admin password.
	Allowed users	Whitelist of allow users	From all numbers, from group or from single number.
16.	Switch monitoring on/off		
	Enable	This check box will enable and disable this function.	Allows monitoring control via SMS.
	Action	The action to be performed when this rule is met.	Turn monitoring ON or OFF.
	SMS text	SMS text which will turn monitoring ON/OFF	SMS text can contain letters, numbers, spaces and special symbols. Capital letters also matters.
	Authorization method	What kind of authorization to use for SIM management.	By serial or by router admin password.
	Allowed users	Whitelist of allow users	From all uers, from group or from single number.
17.	Monitoring status		
	Enable	This check box will enable and disable this function.	Allows monitoring control via SMS.
	Action	The action to be performed when this rule is met.	Get monitoring status
	SMS text	SMS text which will turn monitoring ON/OFF	SMS text can contain letters, numbers, spaces and special symbols. Capital letters also matters.
	Authorization method	What kind of authorization to use for SIM management.	By serial or by router admin password.
18.	UCI API		
	Enable	This check box will enable and disable this function.	Allows monitoring control via SMS.

Action	The action to be performed when this rule is met.	UCI lets you set or get any parameter from router's configuration files.
SMS text	SMS text which will turn monitoring ON/OFF	SMS text can contain letters, numbers, spaces and special symbols. Capital letters also matters.
Authorization method	What kind of authorization to use for SIM management.	By serial or by router admin password.

UCI via SMS parameters:

UCI lets you set or get any parameter from router's configuration files. Following are syntax examples:

1.	<code>uci get config.section.option"</code>	Get config option value.
2.	<code>uci set config.section.option=value"</code>	Set config option
3.	<code>uci show config</code>	Shows the config file.
4.	<code>uci show config.section</code>	Shows the exact part of config file (Eg. <code>uci show network.ppp.apn"</code>)

3.3.1

8.6.2 Call Utilities

Allow users to call to the router in order to perform one of the actions: Reboot, Get Status, turn WiFi ON/OFF, turn Mobile data ON/OFF. Only thing that is needed is to call routers SIM card number from allowed phone (user) and RUT900 will perform all actions that are assigned for this particular number. To configure new action on call rules you just need to click the Add button in the „New Call rule” section. After that, you get in to the “Modify Call Rule section”.

The screenshot shows the 'Call Configuration' section with the 'Modify Call Rule' sub-section. The 'Enable' checkbox is unchecked. The 'Action' dropdown is set to 'Reboot', and the 'Allowed users' dropdown is set to 'From all numbers'. There is also an unchecked checkbox for 'Get status via SMS after reboot'. At the bottom, there are 'Back to Overview' and 'Save' buttons.

This screenshot is identical to the one above, but the 'Enable' checkbox is now checked, indicating that the call rule is active.

1.	Enable	Enable/Disable	Enables the rule
2.	Action	Reboot	Action to be taken after receiving a call, you can choose from following actions: Reboot, Send status, Switch WiFi, Switch mobile data.
3.	Allowed users	From all numbers	Allows to limit action triggering from all users, to user groups or single user numbers
4.	Get status via SMS after reboot	Enable/Disable	Enables automatic message sending with router status information after reboot

8.6.2.1 Incoming Calls

The screenshot shows the 'Incoming Calls' configuration section. There is a checkbox labeled 'Reject unrecognized incoming calls' which is checked. A 'Save' button is located at the bottom right of the section.

1.	Reject unrecognized incoming calls	Enable/Disable	If a call is made from number that is not in the active rule list, it can be rejected with this option

8.6.3 User Groups

Give possibility to group phone numbers for SMS management purposes. You can then later use these groups in all related SMS functionalities. This option helps if there are several Users who should have same roles when managing router via SMS. You can create new user group by entering group name and clicking on Add button in “Create New User Group” section. After that you get to “Modify User Group” section.

Modify User Group

Group name

Phone number 



1.	Group name	Group1	Name of grouped phone numbers
2.	Phone number	+37061111111	Number to add to users group, must match international format. You can add phone numbers fields by clicking on the green + symbol

8.6.4 SMS Management

8.6.4.1 Read SMS

In SMS Management page Read SMS you can read and delete received/stored SMS.

Date	Sender	Message	
2016-05-05 13:51:56	+370612345678	Labas	<input type="checkbox"/>

Showing 1 to 1 of 1 entries

Refresh Delete Select all

8.6.4.2 Send SMS

Phone Number: +3701111111

Message: My text.

SMS 1 (152 characters left)

Send

1.	Phone number	+3701111111	Recipients phone number. Should be preceded with country code, i.e. "+370"
2.	Message	My text.	Message text, special characters are allowed.

3.3.1.1

8.6.4.3 Storage

With **storage** option you can choose for router NOT to delete SMS from SIM card. If this option is not used, router will automatically delete all incoming messages after they have been read. Message status “read/unread” is examined every 60 seconds. All “read” messages are deleted.

Read SMS Send SMS Storage

SMS Storing

Configuration

Save messages on SIM

SIM card memory Used:0 Available: 50

Leave free space

Save

1.	Save messages on SIM	Enabled / Disabled	Enables received message storing on SIM card
2.	SIM card memory	Used: 0 Available: 50	Information about used/available SIM card memory
3.	Leave free space	1	How much memory (number of message should be left free

8.6.5 Remote Configuration

RUT230 can be configured via SMS from another RUT230. You only have to select which configuration details to send, generate the SMS Text, type in the phone number and Serial number of the router that you wish to configure and Send the SMS.

Total count of SMS is managed automatically. You should be aware of possible number of SMS and use this feature at your own responsibility. It should not, generally, be used if you have high cost per SMS. This is especially relevant if you will try to send whole OpenVPN configuration, which might accumulate ~40 SMS.

8.6.5.1 Receive configuration

This section controls how configuration initiation party should identify itself. In this scenario RUT230 itself is being configured.

Receive Send

Recieve Configuration

Receive Configuration

Enable

Authorization method: By router admin password

Allowed users: From all numbers

Save

1.	Enable	Enabled / Disabled	Enables router to receive configuration
1.	Authorization method	No authorization / By serial By administration password	Describes what kind of authorization to use for SMS management. Method at Receiving and Sending ends must match
2.	Allowed users	From all numbers From group From single number	Gives greater control and security measures

Note, that for safety reasons Authorization method should be configured before deployment of the router.

8.6.5.2 Send configuration

This section lets you configure remote RUT230 devices. The authorization settings must confirm to those that are set on the receiving party.

Send Configuration

Configuration Message

Network
VPN

Generate SMS New

WAN

Interface Mobile

Primary SIM card SIM1

Mobile connection Use pppd mode

APN internet.mnc012.mcc34c

Dialing number +37060000001

Authentication method CHAP

User name admin

Password ••••••

Service mode 3G preferred

LAN

IP address 192.168.1.1

IP netmask 255.255.255.0

IP broadcast 192.168.1.255

1.	Generate SMS	New/From current configuration	Generate new SMS settings or use current device configuration
2.	Interface	Mobile/Wired	Interface type used for WAN (Wide Area Network) connection
3.	WAN	Enable/Disable	Include configuration for WAN (Wide Area Network)
4.	LAN	Enable/Disable	Include configuration for LAN (Local Area Network)
6.	Protocol	Static/DHCP	Network protocol used for network configuration parameters management
7.	IP address	"217.147.40.44"	IP address that router will use to connect to the internet
8.	IP netmask	"255.255.255.0"	That will be used to define how large the WAN (Wide Area Network) network is
11.	IP gateway	"217.147.40.44"	The address where traffic destined for the internet is routed to

12.	IP broadcast	"217.147.40.255"	A logical address at which all devices connected to a multiple-access communications network are enabled to receive datagrams.
13.	Primary SIM card	SIM1/SIM2	A SIM card that will be used as primary
14.	Mobile connection	Use pppd mode Use ndis mode	An underlying agent that will be used for mobile data connection creation and management
15.	APN	"internet.mnc012.mcc345.gprs"	(APN) is the name of a gateway between a GPRS or 3G mobile networks and another computer network, frequently the public Internet.
16.	Dialing number	"+37060000001"	A phone number that will be used to establish a mobile PPP (Point-to-Point Protocol) connection
17.	Authentication method	CHAP/PAP/None	Select an authentication method that will be used to authenticate new connections on your GSM carrier's network
18.	User name	"admin"	User name used for authentication on your GSM carrier's network
19.	Password	"password"	Password used for authentication on your GSM carrier's network
20.	Service mode	auto 3G only 2G only	You can add as many phone numbers as you need. Dropdown list with additional rows will show up if you click on "add" icon at the end of phone number row.
21.	IP address	"192.168.1.1"	IP address that router will use on LAN (Local Area Network) network
22.	IP netmask	"255.255.255.0"	A subnet mask that will be used to define how large the LAN (Local Area Network) network is
23.	IP broadcast	"192.168.1.255"	A logical address at which all devices connected to a multiple-access communications network are enabled to receive datagrams

Send Configuration Message

```
network.wan.ifname=eth1, network.ppp.enabled=0, network.wan.proto=static,
network.wan.ipaddr=217.147.40.44, network.wan.netmask=255.255.255.0,
network.wan.gateway=217.147.40.44, network.wan.broadcast=217.147.40.255
```

Phone number

Authorization method

1.	Message text field	Generated configuration message	Here you can review and modify configuration message text to be sent
2.	Phone number	"+37060000001"	A phone number of router which will receive the configuration
3.	Authorization method	No authorization By serial	What kind of authorization to use for remote configuration

8.6.6 Statistics

In statistics page you can review how much SMS was sent and received on both SIM card slots. You can also reset the counters.

SMS Utilities	Call Utilities	User Groups	SMS Management	Remote Configuration	Statistics
Statistics					
SMS Statistics					
SIM Card	Sent SMS	Received SMS			
SIM 1	0	0			<input type="button" value="Reset"/>
SIM 2	0	0			<input type="button" value="Reset"/>

3.4

8.7 SNMP

SNMP settings window allows you to remotely monitor and send GSM event information to the server.

8.7.1 SNMP Settings

1.	Enable SNMP service	Enable/Disable	Run SNMP (Simple Network Management Protocol) service on system's start up
2.	Enable remote access	Enable/Disable	Open port in firewall so that SNMP (Simple Network Management Protocol) service may be reached from WAN
3.	Port	161	SNMP (Simple Network Management Protocol) service's port
4.	Community	Public/Private/Custom	The SNMP (Simple Network Management Protocol) Community is an ID that allows access to a router's SNMP data
5.	Community name	custom	Set custom name to access SNMP
6.	Location	Location	Trap named sysLocation
7.	Contact	email@example.com	Trap named sysContact
8.	Name	Name	Trap named sysName

Variables/OID

1.	1.3.6.1.4.1.99999.1.1.1	Modem IMEI
2.	1.3.6.1.4.1.99999.1.1.2	Modem model
3.	1.3.6.1.4.1.99999.1.1.3	Modem manufacturer
4.	1.3.6.1.4.1.99999.1.1.4	Modem revision
5.	1.3.6.1.4.1.99999.1.1.5	Modem serial number
6.	1.3.6.1.4.1.99999.1.1.6	SIM status
7.	1.3.6.1.4.1.99999.1.1.7	Pin status
8.	1.3.6.1.4.1.99999.1.1.8	IMSI
9.	1.3.6.1.4.1.99999.1.1.9	Mobile network registration status
10.	1.3.6.1.4.1.99999.1.1.10	Signal level
11.	1.3.6.1.4.1.99999.1.1.11	Operator currently in use
12.	1.3.6.1.4.1.99999.1.1.12	Operator number (MCC+MNC)
13.	1.3.6.1.4.1.99999.1.1.13	Data session connection state
14.	1.3.6.1.4.1.99999.1.1.14	Data session connection type
15.	1.3.6.1.4.1.99999.1.1.15	Signal strength trap
16.	1.3.6.1.4.1.99999.1.1.16	Connection type trap

8.7.2 TRAP Settings

1.	SNMP Trap	Enable/Disable	Enable SNMP (Simple Network Management Protocol) trap functionality
2.	Host/IP	192.168.99.155	Host to transfer SNMP (Simple Network Management Protocol) traffic to
3.	Port	162	Port for trap's host
4.	Community	Public/Private	The SNMP (Simple Network Management Protocol) Community is an ID that allows access to a router's SNMP data

8.8 SMS Gateway

8.8.1 Post/Get Configuration

Post/Get Configuration allows you to perform actions by writing these requests URI after your device IP address.

1.	Enable	Enabled / Disabled	Enable SMS management functionality through POST/GET
2.	User name	admin	User name used for authorization
3.	Password	*****	Password used for authorization (default- admin01)

Do not forget to change parameters in the url according to your POST/GET Configuration!

8.8.1.1 SMS by HTTP POST/GET

It is possible to read and send SMS by using valid HTTP POST/GET syntax. Use web browser or any other compatible software to submit HTTP POST/GET string to router. Router must be connected to GSM network when using “SMS send” feature.

1.	View mobile messages list	/cgi-bin/sms_list?username=admin&password=admin01
2.	Read mobile message	/cgi-bin/sms_read?username=admin&password=admin01&number=1
3.	Send mobile messages	/cgi-bin/sms_send?username=admin&password=admin01&number=0037060000001&text=testmessage
4.	View mobile messages total	/cgi-bin/sms_total?username=admin&password=admin01
5.	Delete mobile message	/cgi-bin/sms_delete?username=admin&password=admin01&number=1

8.8.1.2 Syntax of HTTP POST/GET string

http://{IP_ADDRESS}	/cgi-bin/sms_read? username={your_user_name}&password={your_password}&number={MESSAGE_INDEX}	Read message
	/cgi-bin/sms_send? username={your_user_name}&password={your_password}&number={PHONE_NUMBER}&text={MESSAGE_TEXT}	Send message
	/cgi-bin/sms_delete? username={your_user_name}&password={your_password}&number={MESSAGE_INDEX}	Delete message
	/cgi-bin/sms_list? username={your_user_name}&password={your_password}	List all messages
	/cgi-bin/sms_total? username={your_user_name}&password={your_password}	Number of messages in memory

Note: parameters of HTTP POST/GET string are in capital letters inside curly brackets. Curly brackets (“{ }”) are not needed when submitting HTTP POST/GET string.

8.8.1.3 Parameters of HTTP POST/GET string

1.	IP_ADDRESS	IP address of your router
2.	MESSAGE_INDEX	SMS index in memory
3.	PHONE_NUMBER	Phone number of the message receiver. Note: Phone number must contain country code. Phone number format is: 00{COUNTRY_CODE} {RECEIVER_NUMBER}. E.g.: 0037062312345 (370 is country code and 62312345 is receiver phone number)
4.	MESSAGE_TEXT	Text of SMS. Note: Maximum number of characters per SMS is 160. You cannot send longer messages. It is suggested to use alphanumeric characters only.

After every executed command router will respond with return status.

8.8.1.4 Possible responses after command execution

1.	OK	Command executed successfully
2.	ERROR	An error occurred while executing command
3.	TIMEOUT	No response from the module received
4.	WRONG_NUMBER	SMS receiver number format is incorrect or SMS index number is incorrect
5.	NO MESSAGE	There is no message in memory by given index
6.	NO MESSAGES	There are no stored messages in memory

8.8.1.5 HTTP POST/GET string examples

http://192.168.1.1/cgi-bin/sms_read?username=admin&password=admin01&number=2

http://192.168.1.1/cgi-bin/sms_send?username=admin&password=admin01&number=0037060000001&text=message

http://192.168.1.1/cgi-bin/sms_delete?username=admin&password=admin01&number=4

http://192.168.1.1/cgi-bin/sms_list?username=admin&password=admin01

http://192.168.1.1/cgi-bin/sms_total?username=admin&password=admin01

8.8.2 Scheduled Messages

Scheduled messages allow to periodically sending mobile messages to specified number.

8.8.2.1 Scheduled Messages Configuration

1.	Enable	Enable/Disable	Activates periodical messages sending.
2.	Recipient's phone number	"+37060000001"	Phone number that will receive messages.
3.	Message text	"Test"	Message that will be send.
4.	Message sending interval	Day/Week/Month/Year	Message sending period.

8.8.3 Auto Reply Configuration

Auto reply allows replying to every message that router receives to everyone or to listed numbers only.

1.	Enable	Enable/Disable	Enable auto reply to every received mobile message.
2.	Don't save received message	Enable/Disable	If enabled, received messages are not going to be saved
3.	Mode	Everyone / Listed numbers	Specifies from which senders received messages are going to be replied.

4.	Message	"Text"	Message text that will be sent in reply.
----	---------	--------	------------------------------------------

8.8.4 SMPP

SMPP Server Configuration

Transmitter Configuration

Enable

User name

Password 

Server port

1.	Enable	Enable/Disable	Enables SMPP server
2.	User name	admin	User name for authentication on SMPP server
3.	Password	●●●●●●●●	Password for authentication on SMPP server
4.	Server port	7777	A port will be used for SMPP server communications. Allowed all not used ports [0-65535]

8.9 Hotspot

Wireless hotspot provides essential functionality for managing an open access wireless network. In addition to standard RADIUS server authentication there is also the ability to gather and upload detailed logs on what each device (denoted as a MAC address) was doing on the network (what sites were traversed, etc.).

8.9.1 General settings

8.9.1.1 Main settings

General Settings

Enable

AP IP

Logout address

Authentication mode

Terms of Service

External landing page

Protocol

HTTPS redirect

Use custom DNS

Session Settings

Name	Download bandwidth	Upload bandwidth	Download limit	Upload limit	Period	
unlimited	Unlimited	Unlimited	Unlimited	Unlimited	-	<input type="button" value="Edit"/>

Template name

Users Configuration

User name	Password	Idle timeout	Session timeout	Download bandwidth	Upload bandwidth	Session template
<i>There are no users created yet.</i>						

Username	Password	Session Template	
<input type="text" value="admin"/>	<input type="password" value="*****"/>	<input type="text" value="unlimited"/>	<input type="button" value="Add"/>

1.	Enabled	Check this flag to enable hotspot functionality on the router.
2.	AP IP	Access Point IP address. This will be the address of the router on the hotspot network. The router will automatically create a network according to its own IP and the CIDR number that you specify after the slash. E.g. "192.168.2.254/24" means that the router will create a network with the IP address 192.168.182.0, netmask 255.255.255.0 for the express purpose of containing all the wireless clients. Such a network will be able to have 253 clients (their IP addresses will be automatically granted to them and will range from 192.168.2.1 to 192.168.2.253).

1.	Radius server #1	The IP address of the RADIUS server that is to be used for Authenticating your wireless clients.
2.	Radius server #2	The IP address of the second RADIUS server.
3.	Authentication port	RADIUS server authentication port.
4.	Accounting port	RADIUS server accounting port.
5.	Radius secret key	The secret key is used for authentication with the RADIUS server
6.	UAM port	Port to bind for authenticating clients
7.	UAM UI port	UAM UI port
8.	UAM secret	Shared secret between UAM server an hotspot
9.	NAS Identifier	NAS Identifier
10.	Swap octets	Swap the meaning of input octets and output as it related to RADIUS attributes
11.	Location name	The name of location

1.	External landing page	Enables the use of external landing page.
2.	Landing page address	The address of external landing page
3.	HTTPS redirect	Redirects HTTP pages to landing page.

8.9.1.2 List Of Addresses The Client Can Access Without First Authenticating

Wireless Hotspot Configuration

General Settings

Main Settings

Session Settings

Logout address

List Of Addresses The Client Can Access Without First Authenticating

Enable	Address	Port	Allow subdomains	
<input type="checkbox"/>	<input style="width: 100%;" type="text"/>	<input style="width: 100%;" type="text"/>	<input type="checkbox"/>	<input type="button" value="Delete"/>

1.	Logout address	IP address to instantly logout a client addressing it
2.	Enable	Enable address accessing without first authenticating
3.	Address	Domain name, IP address or network segment
4.	Port	Port number
5.	Allow subdomains	Enable/Disable subdomains

8.9.2 Internet Access Restriction Settings

Allows disable internet access on specified day and hour of every week.

RUT200

Internet Access Restriction Settings

Select Time To Restrict Access On Hotspot RUT200

Days/Hours	0-1h	1-2h	2-3h	3-4h	4-5h	5-6h	6-7h	7-8h	8-9h	9-10h	10-11h	11-12h	12-13h	13-14h	14-15h	15-16h	16-17h	17-18h	18-19h	19-20h	20-21h	21-22h	22-23h	23-24h
Monday																								
Tuesday																								
Wednesday																								
Thursday																								
Friday																								
Saturday																								
Sunday																								

Internet access allowed

Internet access blocked

8.9.3 Logging

8.9.3.1 Configuration

Configuration
Log

Wireless Hotspot Logging Settings

Logging To FTP Settings

Enable

Server address

User name

Password

Port

1.	Enable	Check this box if you want to enable wireless traffic logging. This feature will produce logs which contain data on what websites each client was visiting during the time he was connected to your hotspot.
2.	Server address	The IP address of the FTP server to which you want the logs uploaded.
3.	Username	The username of the user on the aforementioned FTP server.
4.	Password	The password of the user.
5.	Port	The TCP/IP Port of the FTP server.

FTP Upload Settings

You can configure your timing settings for the log upload via FTP feature here.

Mode

Hours

Minutes

Days Monday
 Tuesday
 Wednesday
 Thursday
 Friday
 Saturday
 Sunday

1.	Mode	The mode of the schedule. Use "Fixed" if you want the uploading to be done on a specific time of the day. Use "Interval" if you want the uploading to be done at fixed interval.
2.	Interval	Shows up only when "Mode" is set to Interval. Specifies the interval of regular uploads on one specific day. E.g. If you choose 4 hours, the uploading will be done on midnight, 4:00, 8:00, 12:00, 16:00 and 20:00.
3.	Days	Uploading will be performed on these days only
4.	Hours, Minutes	Shows up only when "Mode" is set to Fixed. Uploading will be done on that specific time of the day. E.g. If you want to upload your logs on 6:48 you will have to simply enter hours: 6 and minutes: 48.

8.9.3.2 Log

Configuration **Log**

Wifi Log

Wifi Log

Events per page Search

MAC ↑	IP ↑	Port ↑	Date ↑	Time ↑
<i>There are no records yet.</i>				

Showing 1 to 1 of 1 entries

8.9.4 Landing Page

8.9.4.1 General Landing Page Settings

With this functionality you can customize your Hotspot Landing page.

The screenshot shows the 'Wireless Hotspot Landing Settings' interface. It features a 'General' tab and a 'Template' tab. The main heading is 'Wireless Hotspot Landing Settings'. Under the 'Landing Page Settings' section, there are several configuration options: 'Page title' is set to 'Teltonika Hotspot'; 'Theme' is set to 'Custom'; 'Upload login page' has a 'Browse...' button and the text 'No file selected.'; 'Login page file' has a 'Download' button. A 'Demo preview' button is located below these settings. At the bottom, there are five expandable sections: 'Terms Of Services', 'Background Configuration', 'Logo Image Configuration', 'Link Configuration', and 'Text Configuration', each with a small square icon to its left.

1.	Page title	Will be seen as landing page title
2.	Theme	Landing page theme selection
3.	Upload login page	Allows to upload custom landing page theme
4.	Login page file	Allows to download and save your landing page file

In the sections – “Terms Of Services”, “Background Configuration”, “Logo Image Configuration”, “Link Configuration”, “Text Configuration” you can customize various parameters of landing page components.

8.9.4.2 Template

In this page you can review landing page template HTML code and modify it.

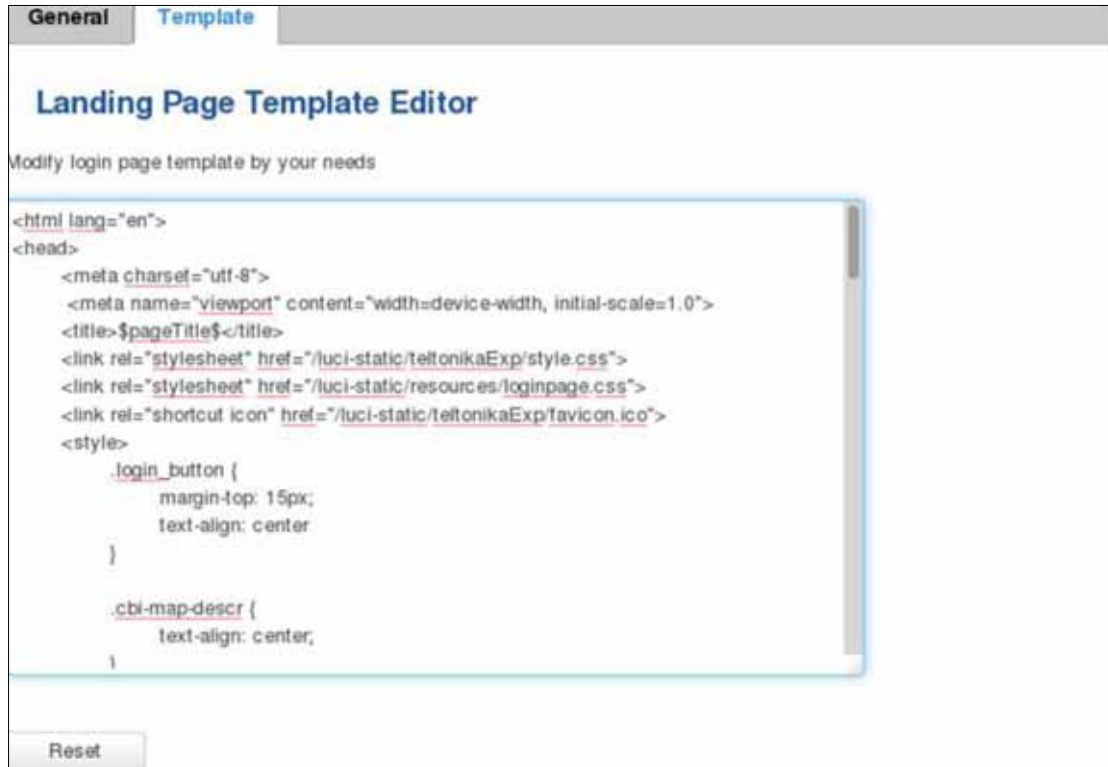

8.9.5 Radius server configuration

An authentication and accounting system used by many Internet Service Providers (ISPs). When you dial in to the ISP you must enter your username and password. This information is passed to a RADIUS server, which checks that the information is correct, and then authorizes access to the ISP system.

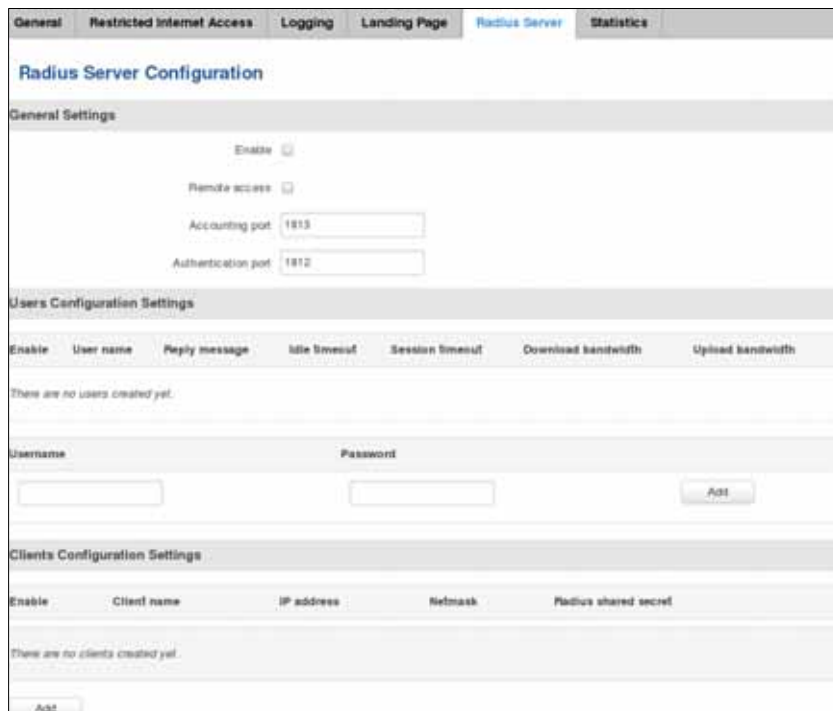

1.	Enable	Activates an authentication and accounting system
2.	Remote access	Activates remote access to radius server
3.	Accounting port	Port on which to listen for accounting
4.	Authentication port	Port on which to listen for authentication

8.9.6 Statistics

On hotspot statistics page you can review statistical information about hotspot instances.

General

Restricted Internet Access

Logging

Landing Page

Radius Server

Statistics

Hotspot Statistics

Hotspot statistics

Events per page

Search

Username ↕	IP ↕	MAC ↕	Start time ↕	End time ↕	Use time ↕	Download ↕	Upload ↕
<i>There are no records yet.</i>							

Showing 1 to 1 of 1 entries

8.10 CLI

CLI or Comand Line Interface functionality allows you to enter and execute comands into routers terminal.

```
Teltonika-RUTm.com login: root
Password:

BusyBox v1.23.2 (2017-04-07 14:16:11 EEST) built-in shell (ash)

  _  _  _  _  _  _  _  _  _  _  _  _  _  _  _  _  _  _  _  _  _  _
 |  |  |  |  |  |  |  |  |  |  |  |  |  |  |  |  |  |  |  |  |  | | | | | | | | | | |
 |_| |_| |_| |_| |_| |_| |_| |_| |_| |_| |_| |_| |_| |_| |_| |_|
 |_| |_| |_| |_| |_| |_| |_| |_| |_| |_| |_| |_| |_| |_| |_| |_|

Teltonika 2016
root@Teltonika-RUTm:~# █
```

Use "CTRL + ALT + SHIFT + T" keyboard shortcut to open CLI in new tab

8.11 Auto Reboot

8.11.1 Ping Reboot

Ping Reboot function will periodically send Ping command to server and waits for echo receive. If no echo is received router will try again sending Ping command defined number times, after defined time interval. If no echo is received after the defined number of unsuccessful retries, router will reboot. It is possible to turn of the router rebooting after defined unsuccessful retries. Therefore this feature can be used as “Keep Alive” function, when router Pings the host unlimited number of times. Possible actions if no echo is received: Reboot, Modem restart, Restart mobile connection, (Re) register, None.

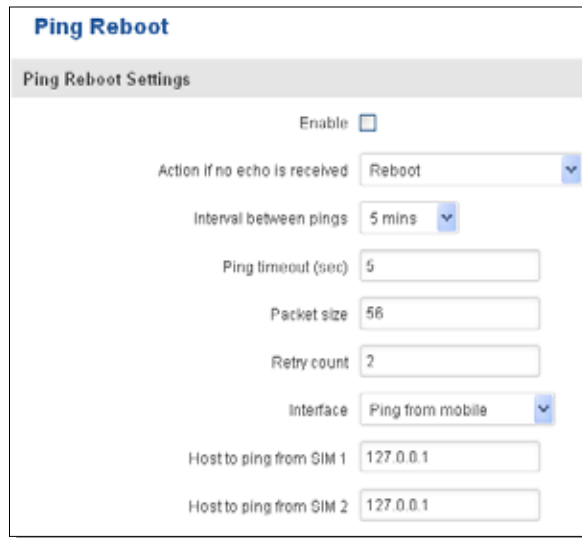

1.	Enable	This check box will enable or disable Ping reboot feature.	Ping Reboot is disabled by default.
2.	Action if no echo is received	Action after the defined number of unsuccessful retries	No echo reply for sent ICMP (Internet Control Message Protocol) packet received
3.	Interval between pings	Time interval in minutes between two Pings.	Minimum time interval is 5 minutes.
4.	Ping timeout (sec)	Time after which consider that Ping has failed.	Range(1-9999)
5.	Packet size	This box allows to modify sent packet size	Should be left default, unless necessary otherwise
6.	Retry count	Number of times to try sending Ping to server after time interval if echo receive was unsuccessful.	Minimum retry number is 1. Second retry will be done after defined time interval.
8.	Interface	Interface used for connection	
7.	Host to ping from SIM 1	IP address or domain name which will be used to send ping packets to. E.g. 127.0.0.1 (or www.host.com if DNS server is configured correctly)	Ping packets will be sending from SIM1.
8.	Host to ping from SIM 2	IP address or domain name which will be used to send ping packets to. E.g. 127.0.0.1 (or www.host.com if DNS server is configured correctly)	Ping packets will be sending from SIM2.

8.11.2 Periodic Reboot

Periodic Reboot

Periodic Reboot Setup

Enable

Days Sunday
 Monday
 Tuesday
 Wednesday
 Thursday
 Friday
 Saturday

Hours

Minutes

1.	Enable	This check box will enable or disable Periodic reboot feature.
2.	Days	This check box will enable router rebooting at the defined days.
3.	Hours, Minutes	Uploading will be done on that specific time of the day

3.5

8.12 Input/Output

8.12.1 Main information

Digital OUT: open collector type values, 30V@0.3A.

Digital IN: non-isolated, Logic low 0...+5V, Logic high +8...+40V

8.12.2 Status

In this page you can review the current state of router's input and output.

The screenshot shows a web interface for configuring digital I/O. It has two main sections: 'Input/Output Status' and 'Custom I/O Status Labels'. The first section shows a table with two rows: 'Digital Input' with state '1' and 'Digital output' with state '0'. The second section has three input fields for 'Digital Input name', 'Input shorted state', and 'Input open state'. Navigation buttons include 'Back to Overview' and 'Save'.

Type	State
Digital Input	1
Digital output	0

Customize Digital Input and state fields

Digital Input name

Input shorted state

Input open state

1.	Digital Input name	Digital Input label
2.	Input shorted state	Input shorted state label
3.	Input open state	Input open state label

3.5.1

Custom I/O Status Labels

Customize Digital galvanically isolated input and state fields

Digital Isolated Input name

High logic level state

Low logic level state

[Back to Overview](#)

[Save](#)

1.	Digital Isolated Input name	Digital Isolated Input name label
2.	High logic level state	High logic level state label
3.	Low logic level state	Low logic level state label

8.12.3 Input

Allows you to set up input parameters and specify what actions should be taken after triggering event of input. In check analog section you can change the analog input checking interval.

Status Input Output

Input/Output

Create rules for Input/Output configuration.

Input Rules

Type	Trigger	Action	Enable	Sort
Digital	Input open	Send SMS	<input checked="" type="checkbox"/>	<div style="display: flex; align-items: center; gap: 5px;"> • • </div>

Input Configuration

Input type	Trigger	Action
Digital ▾	Input open ▾	Send SMS ▾

Save

Status Input Output

Input Configuration

Enable

Input type Digital ▾

Triger Input open ▾

Action Send SMS ▾

SMS text open

Digital input - %di
 Digital isolated input - %ii
 Analog input - %ai
 Analog min voltage - %an
 Analog max voltage - %ax
 New line - %nl

Recipient's phone number +37063000000 +

Back to Overview
Save

1.	Type	Digital	Specifies input type
2.	Trigger	Input open/input shorted/both	Specifies for which trigger rule is applied
3.	Action	Send SMS/Send Email/Change profile/turn WiFi ON or OFF/Reboot/Activate output	Specifies what action is done
4.	Enable	Enable/Disable	Enable input configuration
5.	SMS text	Text	Enter SMS text
6.	Recipient's phone numeber	Phone number	Enter recipient's phone numeber

8.12.4 Output

8.12.4.1 Output configuration

Status	Input	Output			
Output Configuration	ON/OFF	Post/Get Configuration	Periodic Control	Scheduler	

Output Configuration

Output configuration in active state

Open collector output

1.	Open collector output	Low level / High level	Choose what open collector output will be in active state
----	-----------------------	------------------------	-----------------------------------------------------------

8.12.4.2 ON/OFF

Output Configuration	ON/OFF	Post/Get Configuration	Periodic Control	Scheduler	
----------------------	--------	------------------------	------------------	-----------	--

Output

Output

Digital OC output

1.	Digital OC output	Turn on / Turn Off	Manually toggle Digital OC output
----	-------------------	--------------------	-----------------------------------

8.12.4.3 Post/Get Configuration

Output Configuration	ON/OFF	Post/Get Configuration	Periodic Control	Scheduler
----------------------	--------	-------------------------------	------------------	-----------

Post/Get Configuration

Output Post/Get Settings

Enable

Username

Password

1.	Enable	Enable /Disable	Enable POST/GET output functionality
2.	Username	User1	Service user name
3.	Password	Pass1	User password for authentication

Syntax of Output HTTP POST/GET string

With Output post/get you can manage only Output

1.	IP_ADDRESS	192.168.1.1	IP address of your router
2.	Action	On and Off	Specify the action to be taken
3.	Pin	Oc	Specify the output type
4.	Time (sec)	10	Time in seconds after which the output state will go back to usual state

1. Output HTTP POST/GET string examples

- http://192.168.1.1/cgi-bin/output?username=User1&password=Pass1&action=on&pin=relay
- http://192.168.1.1/cgi-bin/output?username=User1&password=Pass1&action=on&pin=relay&time=5
- http://192.168.1.1/cgi-bin/output?username=User1&password=Pass1&action=on&pin=oc
- http://192.168.1.1/cgi-bin/output?username=User1&password=Pass1&action=off&pin=oc

8.12.4.4 Periodic Control

Periodic control function allows user to set up schedule by which the outputs are either turned ON or OFF at specific time.

Output Configuration ON/OFF Post/Get Configuration **Periodic Control** Scheduler

After

Periodic Output Control

Control Rules

Action	Mode	Interval	Hour	Minute	Action timeout	Days	Enable	
On	Fixed	-	-	-	-	-	<input type="checkbox"/>	<input type="button" value="Edit"/> <input type="button" value="Delete"/>

clicking on ADD button (Or Edit, if the rule is already created) you get the second periodic output configuration page with extra parameters to set.

Edit Output Control Rule

Enable

Output

Action

Action timeout

Timeout (sec)

Mode

Hours

Minutes

Days Monday
 Tuesday
 Wednesday
 Thursday
 Friday
 Saturday
 Sunday

1.	Enable	Enable/Disable	Enable this output rule
2.	Output	Digital OC output	Specify the output type
3.	Action	On / Off	Specify the action to be taken
4.	Action timeout	Enabled / Disabled	Enable timeout for this rule
5.	Timeout (sec)	10	Specifies after how much time this action should end.
6.	Mode	Fixed / Interval	Specify the mode of output activation
7.	Hours	15	Specify the hour for rule activation
8.	Minutes	25	Specify the minute for rule activation
9.	Days	Monday	Select the week days for rule activation

8.12.4.5 Scheduler

This function allows you to set up the periodical, hourly schedule for the outputs. You can select on which week days the outputs are going to be on or off.

Output Configuration
ON/OFF
Post/Get Configuration
Periodic Control
Scheduler

Output Scheduler

Configure Scheduled Outputs

Output Digital OC output ▼

Days/Hours	0-1h	1-2h	2-3h	3-4h	4-5h	5-6h	6-7h	7-8h	8-9h	9-10h	10-11h	11-12h	12-13h	13-14h	14-15h	15-16h	16-17h	17-18h	18-19h	19-20h	20-21h	21-22h	22-23h	23-24h
Monday																								
Tuesday																								
Wednesday																								
Thursday																								
Friday																								
Saturday																								
Sunday																								

Digital OC output active

Save

8.13 QoS

QoS (Quality of Service) is the idea that transmission rates, error rates, and other characteristics can be measured, improved, and, to some extent, guaranteed in advance. QoS is of particular concern for the continuous transmission of high-bandwidth video and multimedia information.

QoS can be improved with traffic shaping techniques such as packet, network traffic, and port prioritization.

Interfaces						
Interface	Enable	Calculate overhead	Half-duplex	Download speed (kbit/s)	Upload speed (kbit/s)	
WAN	<input type="checkbox"/>	<input type="checkbox"/>	<input type="checkbox"/>	<input type="text" value="1024"/>	<input type="text" value="128"/>	<input type="button" value="Delete"/>
Interface name: <input type="text" value="WAN"/> <input type="button" value="Add"/>						

1.	Interface	WAN/LAN/PPP	
2.	Enable	Enable/Disable	Enable/disable settings
3.	Calculate overhead	Enable/Disable	Check to decrease upload and download ratio to prevent link saturation
4.	Half-duplex	Enable/Disable	Check to enable data transmission in both direction on a single carrier
5.	Download speed (kbit/s)	1024	Specify maximal download speed
6.	Upload speed (kbit/s)	128	Specify maximal upload speed

Classification Rules							
Target	Source host	Destination host	Service	Protocol	Ports	Number of bytes	Sort
Priority	All	All	All	All	22,53	<input type="text"/>	<input type="button" value="Delete"/>
Normal	All	All	All	TCP	20,21,25,80	<input type="text"/>	<input type="button" value="Delete"/>
Express	All	All	All	All	5190	<input type="text"/>	<input type="button" value="Delete"/>

9 System

9.1 Setup Wizard

The configuration wizard provides a simple way of quickly configuring the device in order to bring it up to basic functionality. The wizard is comprised out of 4 steps and they are as follows:

Step 1 (General change)

First, the wizard prompts you to change the default password. Simply enter the same password into both Password and Confirmation fields, select time zone and press **Save**.

The screenshot shows the 'Step 1 - General' configuration screen. At the top, there are four tabs: 'Step 1 - General' (active), 'Step 2 - Mobile', 'Step 3 - LAN', and 'Step 4 - WiFi'. Below the tabs, the title 'Step - General' is displayed. A message reads: 'First, let's change your router password from the default one.' The 'Password Settings' section contains two password input fields: 'New password' and 'Confirm new password', both with masked characters and toggle icons. The 'Time Zone Settings' section shows the 'Current system time' as '2016-03-16 09:27:33' and a 'Sync with browser' button. The 'Time zone' is set to 'UTC' with a dropdown arrow.

Step 2 (Mobile Configuration)

Next we have to enter your mobile configuration. On a detailed instruction on how this should be done see the Mobile section under Network

The screenshot shows the 'Step 2 - Mobile Configuration' screen. At the top, there are four tabs: 'Step 1 - General', 'Step 2 - Mobile' (active), 'Step 3 - LAN', and 'Step 4 - WiFi'. Below the tabs, the title 'Mobile Configuration' is displayed. A message reads: 'Next, let's configure your mobile settings so you can start using internet right away.' The 'Mobile Configuration' section contains several fields: 'Operator profile' (dropdown menu set to 'None'), 'APN' (text input), 'PIN number' (text input), 'Dialing number' (text input set to '*99#'), 'MTU' (text input set to '1500'), 'Authentication method' (dropdown menu set to 'None'), and 'Service mode' (dropdown menu set to '3G only'). At the bottom, there is a checkbox for 'Show mobile info at login page' which is unchecked. At the very bottom, there are two buttons: 'Skip Wizard' and 'Save'.

Step 3 (LAN)

Next, you are given the chance to configure your LAN and DHCP server options. For a detailed explanation see LAN under Network.

Step 1 - General Step 2 - Mobile **Step 3 - LAN** Step 4 - WiFi

Step - LAN

Here we will setup the basic settings of a typical LAN configuration. The wizard will cover 2 basic configurations: static IP address LAN and DHCP client.

General Configuration

IP address: 192.168.1.1

Netmask: 255.255.255.0

Enable DHCP:

Start: 100

Limit: 150

Lease time: 12h

Skip Wizard Save

Step 4 (WiFi)

The final step allows you to configure your wireless settings in order to set up a rudimentary Access Point.

Step 1 - General Step 2 - Mobile Step 3 - LAN **Step 4 - WiFi**

Step - Wireless

Now let's configure your wireless radio. (Note: if you are currently connecting via wireless and you change parameters, like SSID, encryption, etc. your connection will be dropped and you will have to reconnect with a new set of parameters.)

WiFi Configuration

Enable wireless:

SSID: RUT2xx

Mode: 802.11g+n

Channel: Auto

Encryption: No encryption

Country Code: 00 - World

Skip Wizard Save

When you're done with the configuration wizard, press **Save**.

9.2 Profiles

Router can have 5 configuration profiles, which you can later apply either via WebUI or via SMS. When you add New Profile, you save **current** full configuration of the router. Note: profile names **cannot** exceed 10 symbols.

Configuration Profiles

Manage Profiles

Profile name

Profile name	Created	Action
Profile	2016-03-15	<input type="button" value="Apply"/> <input type="button" value="Delete"/>

9.3 Administration

9.3.1 General

General | Troubleshoot | Backup | Access Control | Diagnostics | MAC Clone | Overview | Monitoring

Administration Settings

Router Name And Host Name

Router name

Host name

Administrator Password

New password

Confirm new password

Language Settings

Language

IPv6 Support

Enable

Login Page

Show mobile info at login page

Show WAN IP at login page

Leds indication

Enable

Restore Default Settings

Restore to default

1.	Router name	Enter your new router name.
2.	Host name	Enter your new host name
3.	New Password	Enter your new administration password. Changing this password will change SSH password as well.
4.	Confirm new password	Re-enter your new administration password.
5.	Language	Website will be translated into selected language.
6.	IPv6 support	Enable IPv6 support on router
7.	Show mobile info at login page	Show operator and signal strength at login page.
8.	Show WAN IP at login page	Show WAN IP at login page.
9	On/Off LEDs	If uncheck, all routers LEDs are off.
1 0	Restore to default	Router will be set to factory default settings

Important notes:

The only way to gain access to the web management if you forget the administrator password is to reset the device factory default settings. Default administrator login settings are:

User Name: **admin**

Password: **admin01**

9.3.2 Troubleshoot

- General
- Troubleshoot**
- Backup
- Access Control
- Diagnostics
- MAC Clone
- Overview
- Monitoring

Troubleshoot Settings

Troubleshoot

System log level

Save log in

Include GSMD information

Include PPPD information

Include chat script information

Include network topology information

System log

Kernel log

Troubleshoot file

TCP dump file

Enable TCP dump

Select interface

Select protocol filter

Select packets direction

Host

Port

Select storage

1.	System log level	Debug level should always be used, unless instructed otherwise.
2.	Save log in	Default RAM memory should always be used unless instructed otherwise.
3.	Include GSMD information	Default setting – enabled should be used, unless instructed otherwise.
4.	Include PPPD information	Default setting – disabled should be used, unless instructed otherwise.
5.	Include Chat script information	Default setting – enabled should be used, unless instructed otherwise.
6.	Include network topology information	Default setting – disabled should be used, unless instructed otherwise.
7.	System Log	Provides on-screen System logging information. It does not, however, substitute troubleshooting file that can be downloaded from System -> Backup and Firmware menu.
8.	Kernel Log	Provides on-screen Kernel logging information. It does not, however, substitute troubleshooting file that can be downloaded from System -> Backup and Firmware menu.
9.	Troubleshoot file	Downloadable archive, that contains full router configuration and all System log files.
10.	TCP dump file	Downloadable archive, that contains TCP dump information from configured values.

4.1.1

9.3.3 Backup

1.	Backup archive	Download current router settings file to personal computer. This file can be loaded to other RUT230 with same Firmware version in order to quickly configure it.
2.	Restore from backup	Select, upload and restore router settings file from personal computer.

Ge

E

Ba

Re

*Only

9.3.3.1 Access control

9.3.3.1.1 General

General
Safety

Access Control

SSH

Enabling remote SSH access makes your device reachable from WAN, this might pose a security risk, especially if you are using a weak or default user password!

Enable SSH access

Remote SSH access

Port

WebUI

Enabling remote HTTP access or remote HTTPS access makes your device reachable from WAN, this might pose a security risk, especially if you are using a weak or default user password!

Enable HTTP access

Enable remote HTTP access

Port

Enable remote HTTPS access

Port

Enable JSON RPC

CLI

Enabling remote CLI access makes your device reachable from WAN, this might pose a security risk, especially if you are using a weak or default user password!

Enable CLI

Enable remote CLI

Port

1.	Enable SSH access	Check box to enable SSH access.
2.	Remote SSH access	Check box to enable remote SSH access.
3.	Port	Port to be used for SSH connection
4.	Enable HTTP access	Enables HTTP access to router
5.	Enable remote HTTP access	Enables remote HTTP access to router
6.	Port	Port to be used for HTTP communication
7.	Enable remote HTTPS access	Enables remote HTTPS access to router
8.	Port	Port to be used for HTTPS communication
9.	Enable JSON RPC	Enables JSON RPC communication
10.	Enable CLI	Enables Command Line Interface
11.	Enable remote CLI	Enables remote Command Line Interface
12.	Port	Port to be used for CLI communication

Note: The router has 2 users: “admin” for WebUI and “root” for SSH. When logging in via SSH use “root”.

9.3.3.1.2 Safety

General	Troubleshoot	Backup	Access Control	Diagnostics	MAC Clone	Overview	Monitoring
---------	--------------	--------	----------------	-------------	-----------	----------	------------

General	Safety
---------	--------

Block Unwanted Access

SSH Access Secure

Enable

Clean after reboot

Fail count

WebUI Access Secure

Enable

Clean after reboot

Fail count

List Of Blocked Addresses

Events per page

Search

Service ▾	Blocked address ▾	Blocked date ▾
<i>There are no addresses blocked</i>		

Showing 1 to 1 of 1 entries

1.	SSH access secure enable	Check box to enable SSH access secure functionality.
2.	Clean after reboot	If check box is selected – blocked addresses are removed after every reboot.
3.	Fail count	Specifies maximum connection attempts count before access blocking.
4.	WebUI access secure enable	Check box to enable secure WebUI access.

9.3.4 Diagnostics

General	Troubleshoot	Backup	Access Control	Diagnostics	MAC Clone	Overview	Monitoring
---------	--------------	--------	----------------	-------------	-----------	----------	------------

Diagnostics

Network Utilities

Host

Action

1.	Host	Enter server IP address or hostname.
2.	Ping	Utility used to test the reach ability of a host on an Internet IP network and to measure the round-trip time for messages sent from the originating host to a destination server. Server echo response will be shown after few seconds if server is accessible.
3.	Traceroute	Diagnostics tool for displaying the route (path) and measuring transit delays of packets across an Internet IP network. Log containing route information will be shown after few seconds.
4.	Nslookup	Network administration command-line tool for querying the Domain Name System (DNS) to obtain domain name or IP address mapping or for any other specific DNS record. Log containing specified server DNS lookup information will be shown after few seconds.

9.3.5 MAC Clone

General	Troubleshoot	Backup	Access Control	Diagnostics	MAC Clone	Overview	Monitoring
MAC Address Clone							
MAC Address Clone							
WAN MAC address		<input type="text" value="02:1E:10:1F:00:00"/>	<input type="button" value="Get PC MAC address"/>	<input type="button" value="Save"/>	<input type="button" value="Restore to default"/>		

1.	WAN MAC address	Enter new WAN MAC address.
----	-----------------	----------------------------

9.3.6 Overview

Select which information you want to get in Overview window (Status -> Overview).

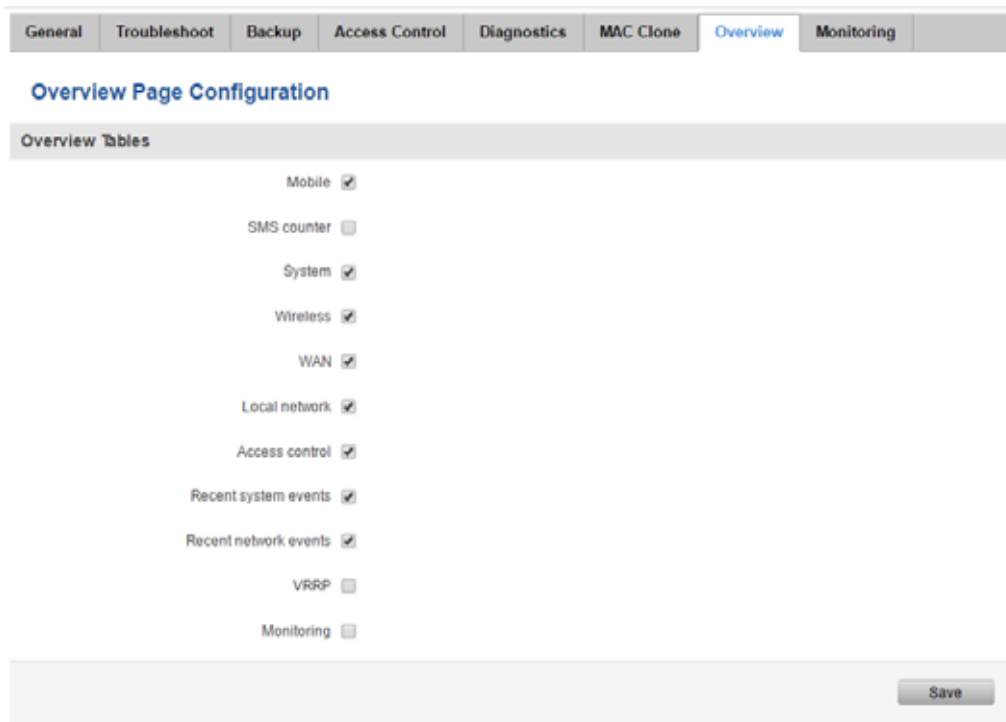

1.	Mobile	Check box to show Mobile table in Overview page
2.	SMS counter	Check box to show SMS counter table in Overview page
3.	System	Check box to show System table in Overview page
4.	Wireless	Check box to show Wireless table in Overview page
5.	WAN	Check box to show WAN table in Overview page
6.	Local network	Check box to show Local network table in Overview page
7.	Access control	Check box to show Access control table in Overview page
8.	Recent system events	Check box to show Recent system events table in Overview page
9.	Recent network events	Check box to show Recent network events table in Overview page
10.	VRRP	Check box to show VRRP table in Overview page
11.	Monitoring	Check box to show Monitoring table in Overview page

9.3.7 Monitoring

Monitoring functionality allows your router to be connected to Remote Monitoring System. Also MAC address and router serial numbers are displayed for convenience in this page, because they are needed when adding device to monitoring system.

General Troubleshoot Backup Access Control Diagnostics MAC Clone Overview **Monitoring**

Remote Monitoring

Remote Access Control

Enable remote monitoring

Hostname

Port

Status	
Monitoring	Enabled
Connection state	Connected to monitoring system
Router serial number	12123434
Router LAN MAC address	00:1e:42:00:00:00

Refresh

Save

1.	Enable remote monitoring	Check box to enable/disable remote monitoring
2.	Hostname	The name of the host
3.	Port	Port number
4.	Monitoring	Shows monitoring status.
5.	Connection state	Shows if router is connected to monitoring system
6.	Router LAN MAC address	MAC address of the Ethernet LAN ports
7.	Router serial number	Serial number of the device

9.4 User scripts

Advanced users can insert their own commands that will be executed at the end of booting process.

Startup Script Management

Insert your own commands to execute at the end of the boot process.

```
# Put your custom commands here that should be executed once
# the system init finished. By default this file does nothing.

exit 0
```

Upload script file No file chosen

Backup script file

In *Script Management* window is shown content of a file `/etc/rc.local`. This file is executed at the end of startup, executing the line: `sh /etc/rc.local` In this script is needed to use `sh` (ash) commands. It should be noted, that this is embedded device and `sh` functionality is not full.

4.2

9.5 Firmware

9.5.1 Firmware

Firmware | FOTA

Firmware

Current Firmware Information		Firmware Available On Server	
Firmware version	RUT2XX_T_00.00.180	Firmware version	N/A
Firmware build date	2017-04-13, 08:52:16		
Kernel version	3.18.44		
Bootloader version	1.0.0		

Firmware Upgrade Settings

Keep mobile settings

Upgrade from file ▼ Firmware image file No file chosen

Keep mobile settings – if the check box is selected router will keep saved user mobile configuration settings after firmware upgrade.

FW image – router firmware upgrade file.

Warning: Never remove router power supply and do not press reset button during upgrade process! This would seriously damage your router and make it inaccessible. If you have any problems related to firmware upgrade you should always consult with local dealer.

9.5.2 FOTA

Firmware **FOTA**

Firmware Over The Air Configuration

Server Settings

Server address:

User name:

Password: 

Enable auto check:

Auto check mode:

WAN wired:

1.	Server address	Specify server address to check for firmware updates. E.g. "http://teltonika.sritis.lt/rut9xx_auto_update/clients/"
2.	User name	User name for server authorization.
3.	Password	Password name for server authorization.
4.	Enable auto check	Check box to enable automatic checking for new firmware updates.
5.	Auto check mode	Select when to perform auto check function.
6.	WAN wired	Allows to update firmware from server only if routers WAN is wired (if box is checked).

9.6 Reboot

Router reboot

Warning! During reboot you will temporarily lose the connection.

Reboot router by pressing button "Reboot".

10 Device Recovery

The following section describes available options for recovery of malfunctioning device. Usually device can become unreachable due to power failure during firmware upgrade or if its core files were wrongly modified in the file system. Teltonika's routers offer several options for recovering from these situations.

10.1 Reset button

Reset button is located on the back panel of the device. Reset button has several functions:

Reboot the device. After the device has started and if the reset button is pressed for up to 4 seconds the device will reboot. Start of the reboot will be indicated by flashing of all 5 signal strength LEDs together with green connection status LED.

Reset to defaults. After the device has started if the reset button is pressed for at least 5 seconds the device will reset all user changes to factory defaults and reboot. To help user to determine how long the reset button should be pressed, signal strength LEDs indicates the elapsed time. All 5 lit LEDs means that 5 seconds have passed and reset button can be released. Start of the reset to defaults will be indicated by flashing of all 5 signal strength LEDs together with red connection status LED. SIM PIN on the main SIM card is the only user parameter that is kept after reset to defaults.

10.2 Bootloader's WebUI

Bootloader also provides a way to recover the router functionality when the firmware is damaged. To make it easier to use bootloader has its own webserver that can be accessed with any web browser.

Procedure for starting bootloader's webserver:

Automatically. It happens when bootloader does not detect master firmware. Flashing all 4 Ethernet LEDs indicate that bootloader's webserver has started.

Manually. Bootloader's webserver can be requested by holding reset button for 3 seconds while powering the device on. Flashing all 4 Ethernet LEDs indicates that bootloader's webserver has started.

Bootloader's WebUI can be accessed by typing this address in the web browser: 192.168.1.1/index.html

Note: it may be necessary to clear web browser's cache and to use incognito/anonymous window to access bootloader's WebUI.

11 Glossary

WAN – Wide Area Network is a telecommunication network that covers a broad area (i.e., any network that links across metropolitan, regional, or national boundaries). Here we use the term WAN to mean the external network that the router uses to reach the internet.

LAN – A local area network (LAN) is a computer network that interconnects computers in a limited area such as a home, school, computer laboratory, or office building.

DHCP – The Dynamic Host Configuration Protocol (DHCP) is a network configuration protocol for hosts on Internet Protocol (IP) networks. Computers that are connected to IP networks must be configured before they can communicate with other hosts. The most essential information needed is an IP address, and a default route and routing prefix. DHCP eliminates the manual task by a network administrator. It also provides a central database of devices that are connected to the network and eliminates duplicate resource assignments.

ETHERNET CABLE – Refers to the CAT5 UTP cable with an RJ-45 connector.

AP – Access point. An access point is any device that provides wireless connectivity for wireless clients. In this case, when you enable WiFi on your router, your router becomes an access point.

DNS – Domain Name System. A server that translates names such as to their respective IPs. In order for your computer or router to communicate with some external server it needs to know it's IP, its name "" just won't do. There are special servers set in place that perform this specific task of resolving names into IPs, called Domain Name servers. If you have no DNS specified you can still browse the web, provided that you know the IP of the website you are trying to reach.

ARP – Short for Address Resolution Protocol a used to convert an into a physical address (called a), such as an address.

PPPoE – Point-to-Point Protocol over Ethernet. PPPoE is a specification for connecting the users on an Ethernet to the internet through a common broadband medium, such as DSL line, wireless device or cable modem.

DSL – digital subscriber line - it is a family of technologies that provide internet access by transmitting digital data using a local telephone network which uses the public switched telephone network.

NAT – network address translation – an internet standard that enables a local-area network (LAN) to use one set of IP addresses for internet traffic and a second set of addresses for external traffic.

LCP – Link Control Protocol – a protocol that is part of the PPP (Point-to-Point Protocol). The LCP checks the identity of the linked device and either accepts or rejects the peer device, determines the acceptable packet size for transmission, searches for errors in configuration and can terminate the link if the parameters are not satisfied.

BOOTP – Bootstrap Protocol – an internet protocol that enables a diskless workstation to discover its own IP address, the IP address of a BOOTP server on the network, and a file to be loaded into memory to boot the machine. This enables the workstation to boot without requiring a hard or floppy disk drive.

TCP – Transmission Control Protocol – one of the main protocols in TCP/IP networks. Whereas the IP protocol deals only with packets, TCP enables two hosts to establish a connection and exchange streams of data. TCP guarantees delivery of data and also guarantees that packets will be delivered in the same order in which they were sent.

TKIP – Temporal Key Integrity Protocol – scrambles the keys using hashing algorithm and, by adding an integrity-checking feature, ensure that the keys haven't been tampered with.

CCMP – Counter Mode Cipher Block Chaining Message Authentication Code Protocol – encryption protocol designed for Wireless LAN products that implement the standards of the IEEE 802.11i amendment to the original IEEE802.11 standard. CCMP is an encrypted data cryptographic encapsulation designed for data confidentiality and based upon the Counter Mode with CBC-MAC (CCM) of the AES (Advanced Encryption Standard) standard.

MAC – Media Access Control. Hardware address which uniquely identifies each node of the network. In IEEE 802 networks, the Data Link Control (DCL) layer of the PSO Reference Model is divided into two sub-layers: the Logical Link Control (LLC) layer and the Media Access Control layer. The MAC layer interfaces directly with the network medium. Consequently, each different type of network medium requires a different MAC layer.

DMZ – Demilitarized Zone – a computer or small subnetwork that sits between a trusted internal network, such as a corporate private LAN, and an untrusted external network, such as the public internet.

UDP – User Datagram Protocol – a connectionless protocol that, like TCP, runs on top of IP networks. Provides very few error recovery services, offering instead a direct way to send and receive datagrams over IP network.

VPN – Virtual Private Network – a network that is constructed by using public wires — usually the Internet — to connect to a private network, such as a company's internal network.

VRRP – Virtual Router Redundancy Protocol - an election protocol that dynamically assigns responsibility for one or more virtual router(s) to the VRRP router(s) on a LAN, allow several routers on a multiaccess link to utilize the same virtual IP address.

GRE Tunnel – Generic Routing Encapsulation - a tunneling protocol developed by Cisco Systems that can encapsulate a wide variety of network layer protocols inside virtual point-to-point links over an Internet Protocol internetwork.

PPPD – Point to Point Protocol Daemon – it is used to manage network connections between two nodes on Unix-like operating systems. It is configured using command-line arguments and configuration files.

SSH – Secure Shell - a program to log into another computer over a network, to execute commands in a remote machine, and to move files from one machine to another. It provides strong authentication and secure communications over insecure channels.

VRRPD – Virtual Router Redundancy Protocol – it is designed to eliminate the single point of failure associated with statically routed networks by automatically providing failover using multiple LAN paths through alternate routers.

SNMP – Simple Network Management Protocol - a set of protocols for managing complex networks. SNMP works by sending messages, called *protocol data units (PDUs)*, to different parts of a network.